



R&D

**Metal Precision
Building Materials**

**R&D Quality Building Materials
R&D International.,Ltd**



**Aluminum Tile Trims
Aluminum Skirting Boards
Aluminum Stair Edge Protection Trims
Aluminum Door Thresholds
Stainless Steel Tile Trims
Stainless Steel Door Threshold Series**

2026

01 Aluminum Alloy Edge Trim Series



- 01 Aluminum Alloy 25×35mm Outdoor Window Sill Cover
- 02 Aluminum Alloy Round Edge Trim Series
- 03 Aluminum Alloy Square Edge Trim Series
- 04 Aluminum Alloy Triangular Edge Trim Series
- 05 Aluminum Alloy Narrow Square Edge Trim Series
- 06 Aluminum Alloy Equal-Sided Square Edge Trim Series
- 07 Aluminum Alloy M-Type Edge Trim Series
- 08 Aluminum Alloy Bullnose L- shaped Edge Trim Series
- 09 Aluminum Alloy L-Type Trim Series
- 10 Aluminum Alloy Line Edge Deco Trim Series
- 11 Aluminum Alloy T-type Edge Trim Series
- 12 Aluminum Alloy U or □ shape Trim Serie
- 13 Aluminum Alloy Internal Corner Trim Series

02 Flooring Series

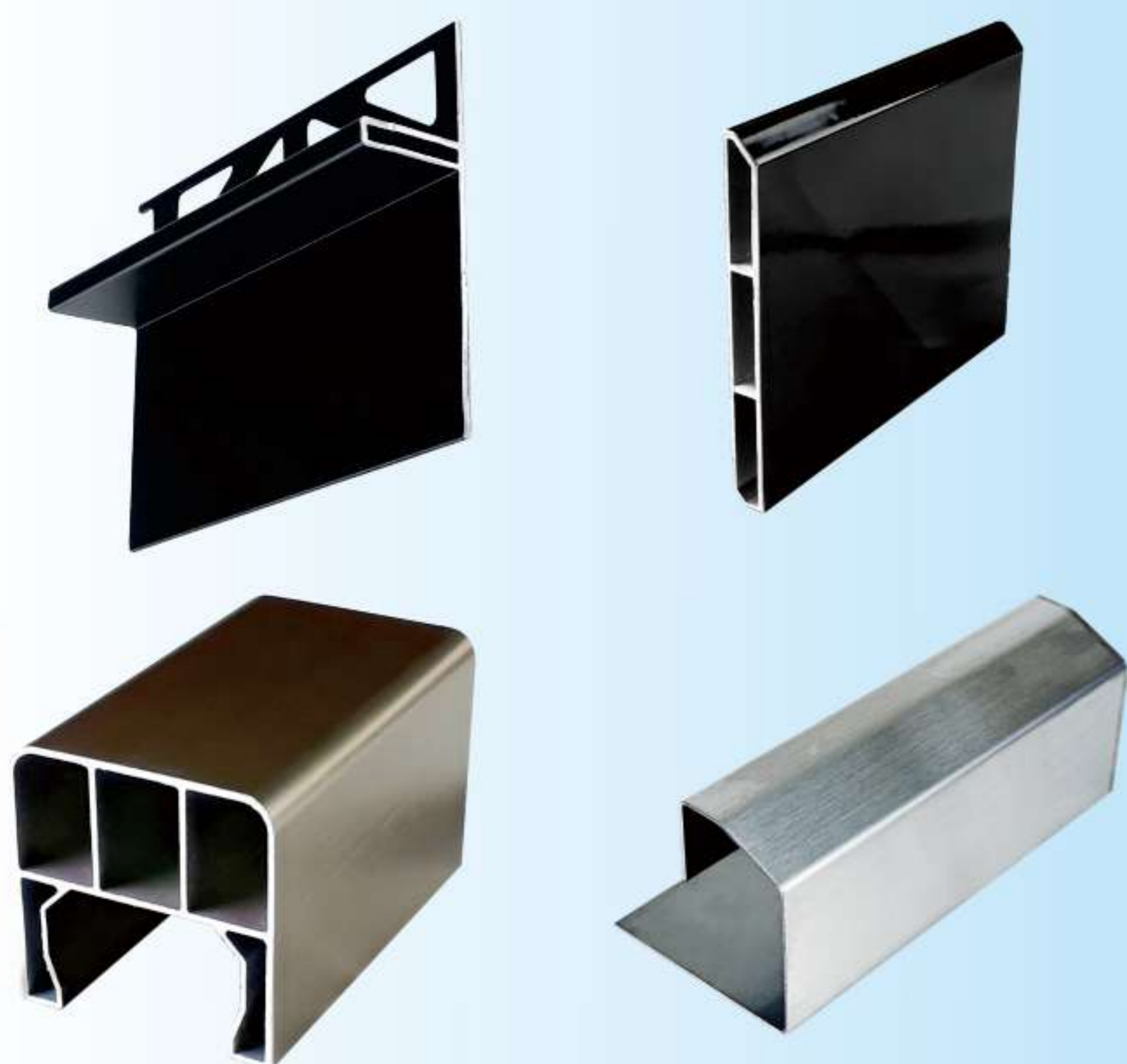

- 14 Post-Installation Recessed Skirting Board Series
- 15 Aluminum Alloy Skirting Board Series
- 16 Pre-Installation Recessed Skirting Board Series
- 17 Aluminum Alloy Stair Edge Protection Trim Series
- 18 Aluminum Alloy Square Stair Edge Protection Trim Series
- 19 Aluminum Alloy Impact-Resistant Stair Edge Protection Trim Series
- 20 Aluminum Glass Groove Trim Series
- 21 Aluminum Alloy Threshold Series
- 22 Stainless Steel Threshold Series
- 23 Stainless Steel High-Low Threshold Series
- 24 Stainless Steel Narrow High-Low Threshold Series

03 Stainless Steel Edge Trim Series



- 25 Stainless Steel U-Type Edge Trim Series
- 26 Stainless Steel Square Edge Trim Series
- 27 Stainless Steel Triangular Edge Trim Series
- 28 Stainless Steel Equal-Sided Square Edge Trim Series
- 29 Stainless Steel Narrow Edge Square Trim Series
- 30 Stainless Steel Large Square Edge Trim Series
- 31 Stainless Steel Rounded Corner Trim Series
- 32 SGS Inspection Report
- 33 .34 Applications in various spaces



Aluminum Alloy 13×35mm Indoor Window Sill Cover



Corner Joint

End Cap

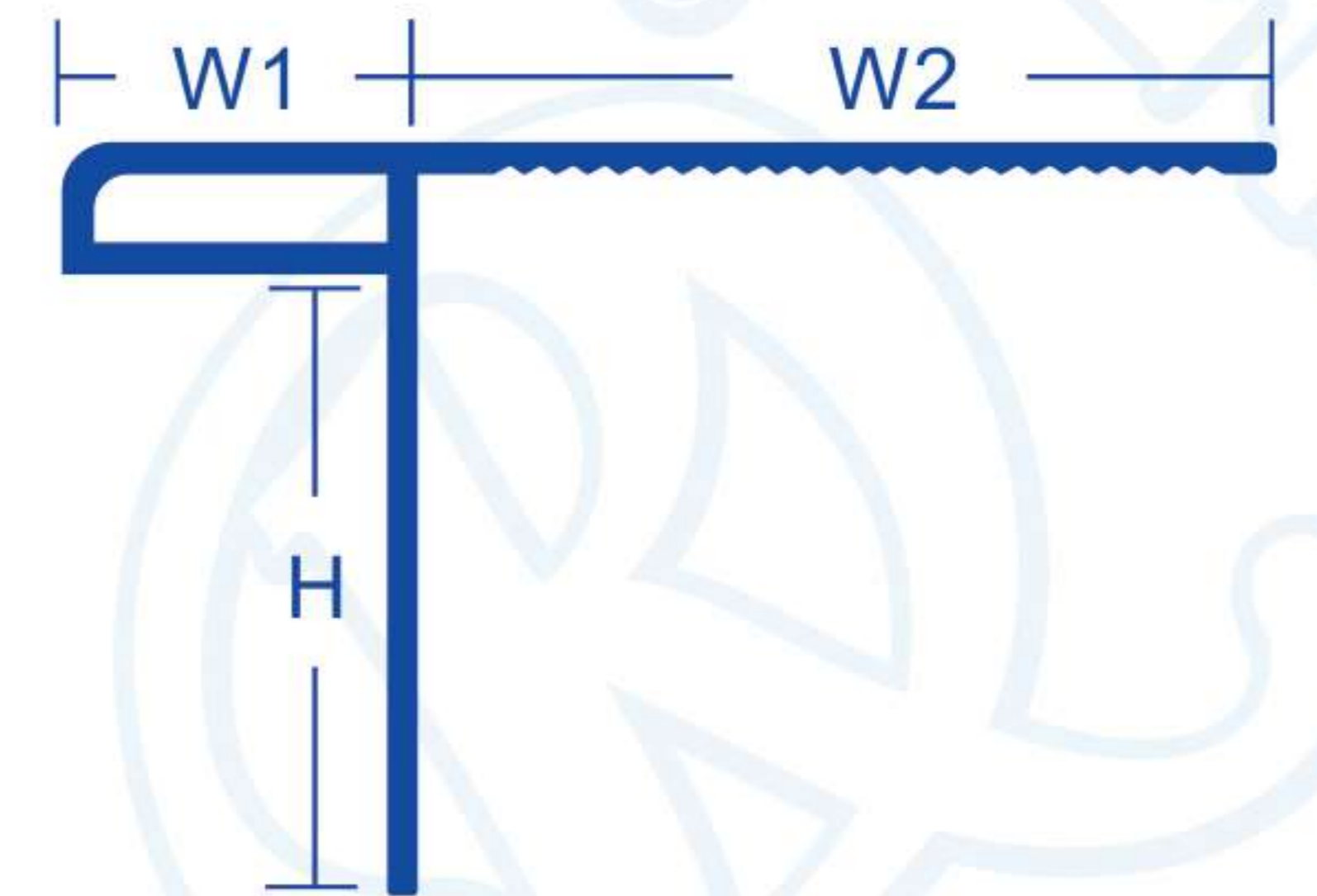
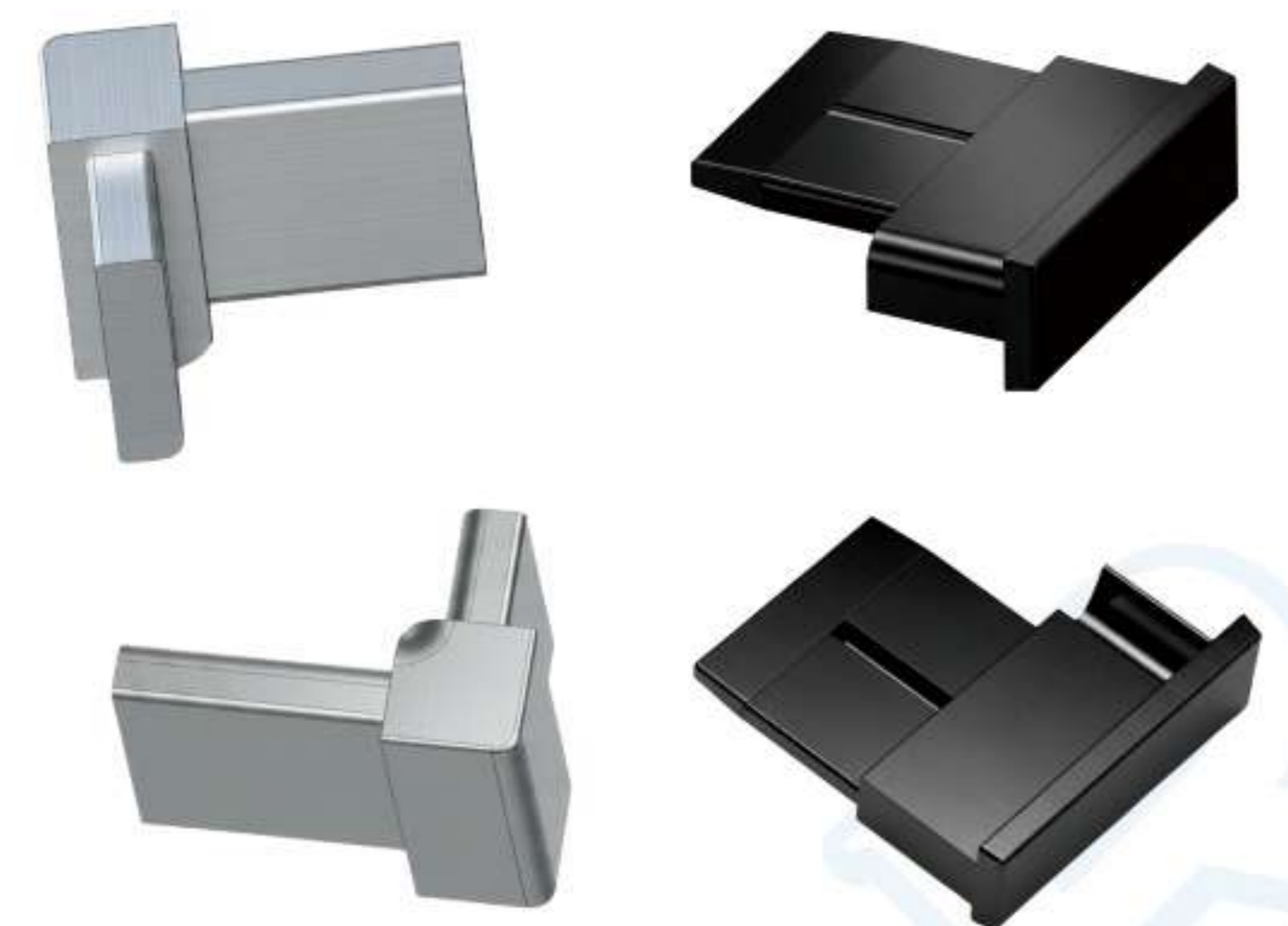

Model No.	Product Name	H(mm)	W1(mm)	W2(mm)
13351D	Aluminum Alloy 13×35mm Indoor Window Sill Cover	25	12.8	35

Specifications and Features

- Standard length: 2.5 meters
 - Integrated L-shaped aluminum profile, easy to cut and install, available in multiple color options
 - Designed to cover exposed window sill edges, enhancing overall interior aesthetics
 - Full range includes corner fittings and end caps for flexible applications
 - Note: Do not use cleaning agents containing salt, acid, or alkaline substances. Residual cement or detergents may corrode the surface—please clean thoroughly with water
 - Caution: Not suitable for installation in high-moisture or water-exposed areas
- Available coating colors: 12 Mist Black / 13 Sand Black / 18 Beige / 19 White / 24 Iron Gray

Color Options

Color Options	12 Matte Black	24 Iron Gray
Model Number		
13351D	✓	✓

Legend: ✓ Standard Product
 ✗ No Color Option Available
 ⊙ Custom Order Available

Construction Scenarios



Installation Process

1. Complete window frame installation and ensure wall surface leveling
2. Install the window sill cover
3. Apply adhesive/sealant evenly along edges and joints
4. Finish by installing surface materials

Accessory Applications

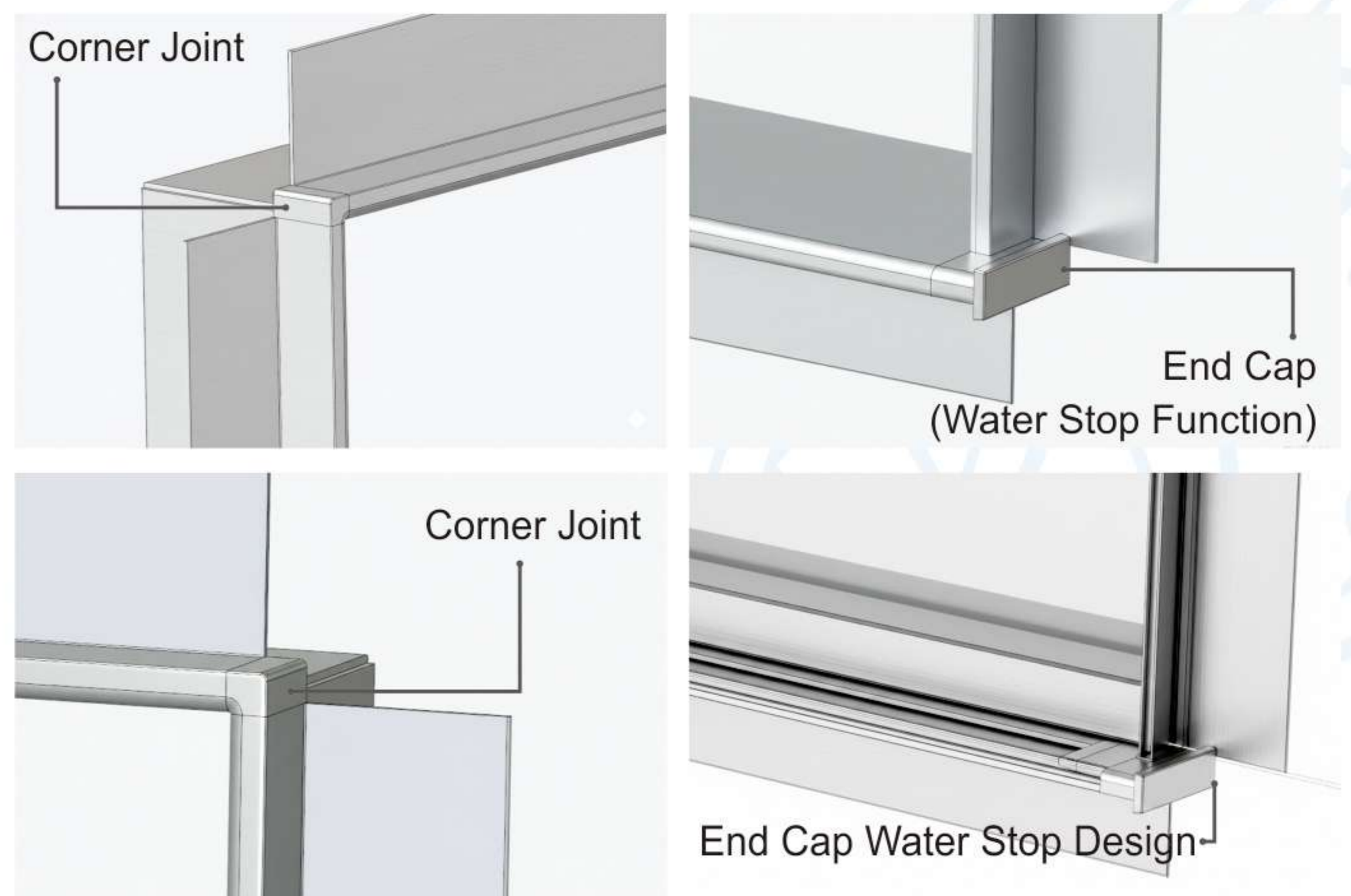



Aluminum Alloy Rounded Corner Trim Edge Series



Model	Product Name	H (Height)	W (Width)
08001P	Aluminum Alloy 8mm Rounded Corner Trim Edge	8.0	8.0
10001P	Aluminum Alloy 10mm Rounded Corner Trim Edge	10.2	10.2
12001P	Aluminum Alloy 12mm Rounded Corner Trim Edge	12.2	12.2

Unit: mm

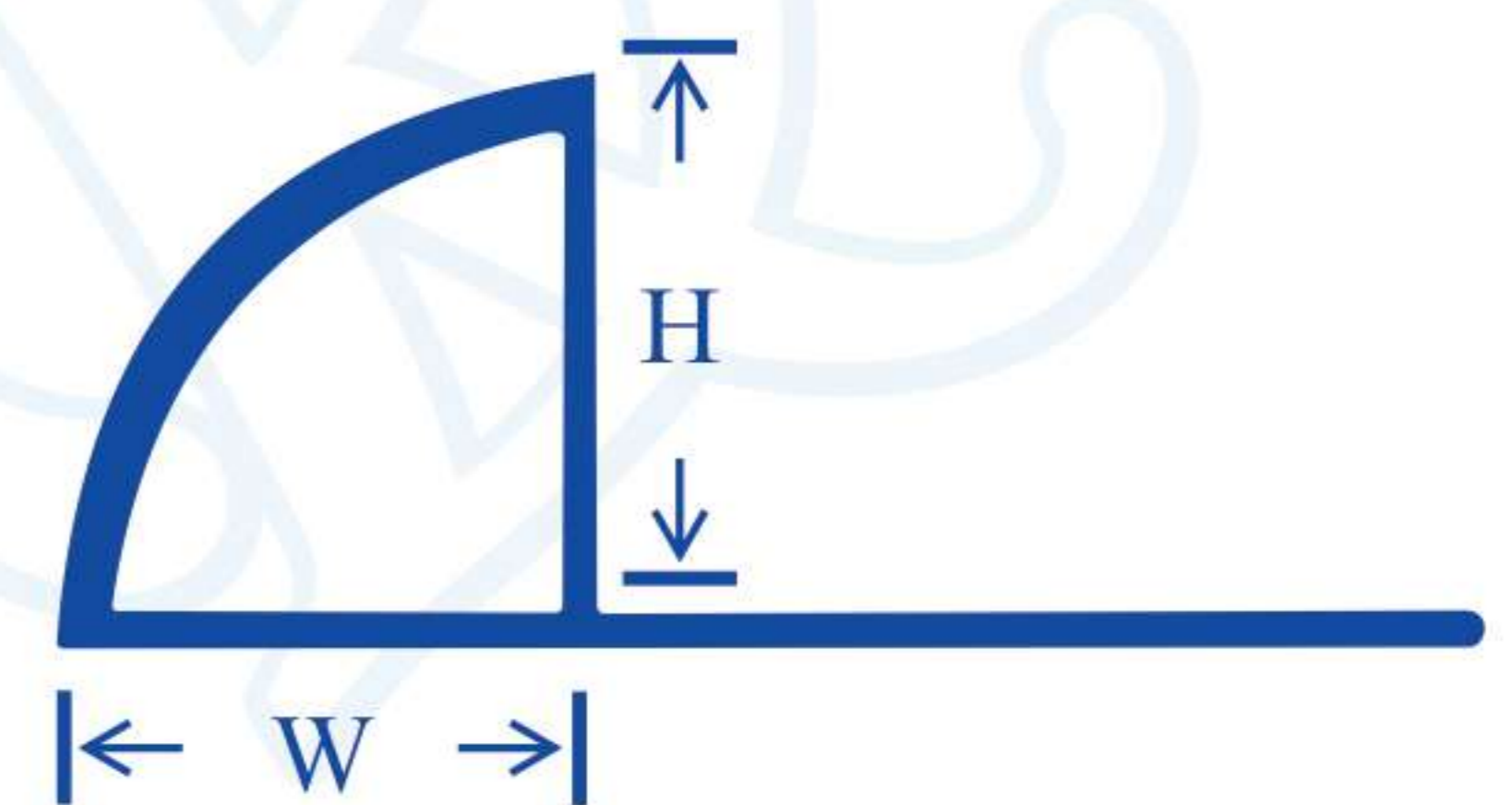

Specifications and Features

- Length: 2.5m.
- Exclusive thickened design with impact-resistant surface; rounded corners prevent injuries.
- Aluminum alloy exterior with an integrated design for easy cutting and installation; available in a wide range of colors.
- All series can be matched with corner components.
- The Silk patterned series is a patented product (Patent Numbers: M460910, D159364, D159365), ensuring authenticity!
- Important Reminder: Please use cleaning agents containing weak acids or neutral pH. Residual cement or alkaline cleaners may corrode the surface. Ensure timely cleaning and drying.
- [Attention]: Painted products should not be installed in wet areas or locations prone to water accumulation (Available painted colors: 12 Matte Black, 13 Sand Black, 18 Ivory, 19 White, 24 Iron Gray).

Color Options

Color Options	12 Matte Black	13 Sandy Black	14 Matte Gold	15 Bright Silver	16 Matte Silver	17 Bright Gold	18 Ivory	19 White	20 Silk Pattern Gold	21 Silk Pattern Silver	22 Silk Pattern Champagne	24 Iron Gray
Model Number												
08001P	✓	✓	⊙	✓	✓	⊙	✓	✓	✗	✗	✗	✓
10001P	✓	✓	⊙	✓	✓	⊙	✓	✓	⊙	✓	✓	✓
12001P	✓	✓	⊙	✓	✓	⊙	✓	✓	⊙	✓	✓	✓

Legend: ✓ Standard Product ✗ No Color Option Available ⊙ Custom Order Available

Construction Scenarios

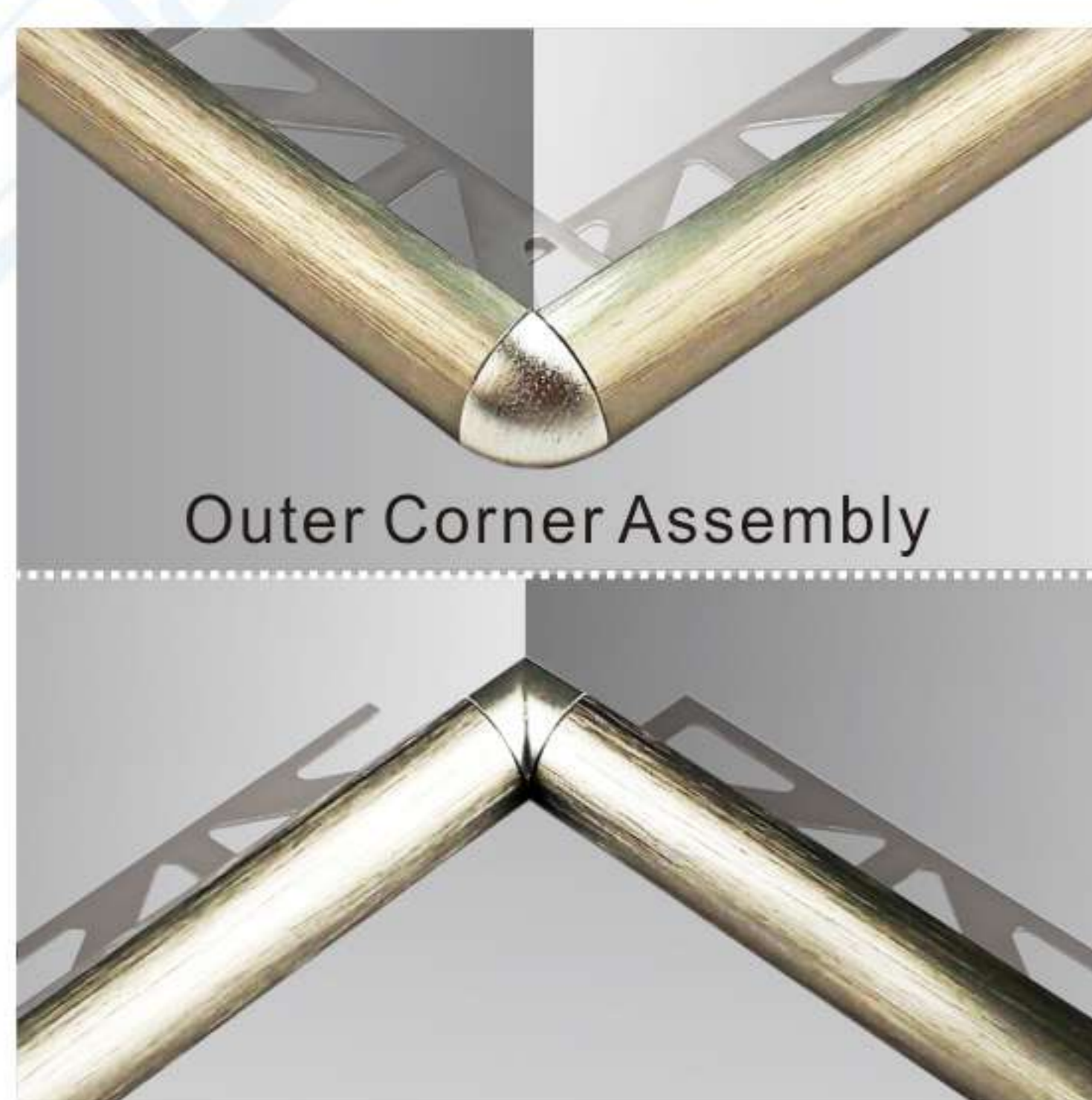

Outer Corner Assembly



Inner Corner Assembly





Aluminum Alloy Square Edge Trim Series

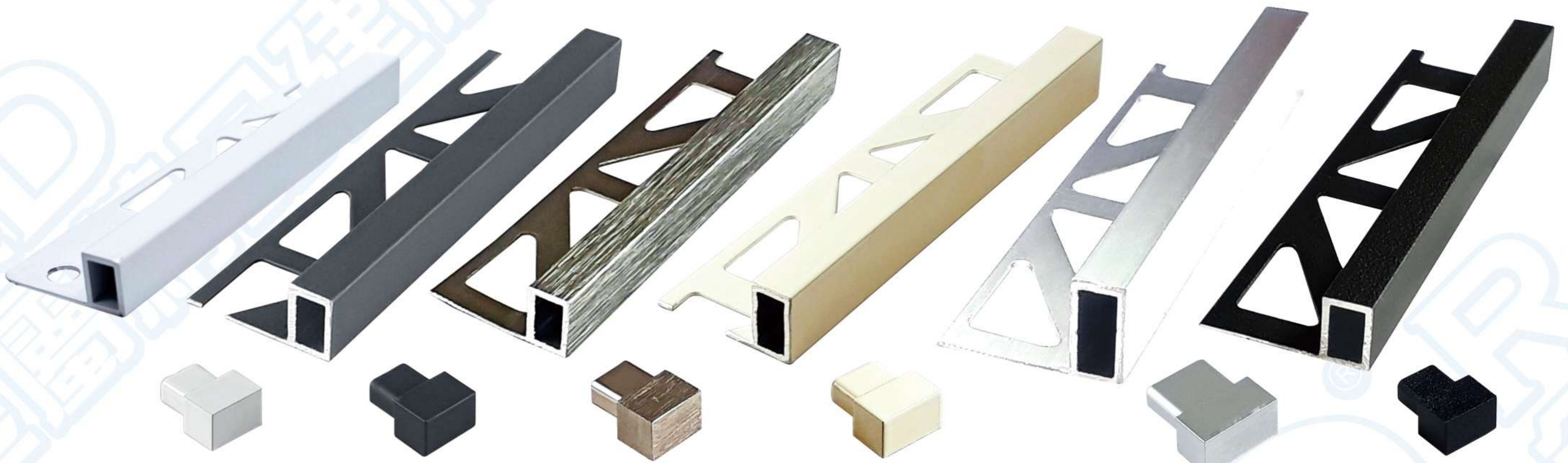

Unit: mm

Model	Product Name	H(mm)	W(mm)
10082L	Aluminum Alloy 10mm Square Trim	10.0	8.0
11081L	Aluminum Alloy 11mm Square Trim	11.0	8.0
12082L	Aluminum Alloy 12.5mm Square Trim	12.5	8.0
15082L	Aluminum Alloy 15mm Square Trim	15.0	8.0

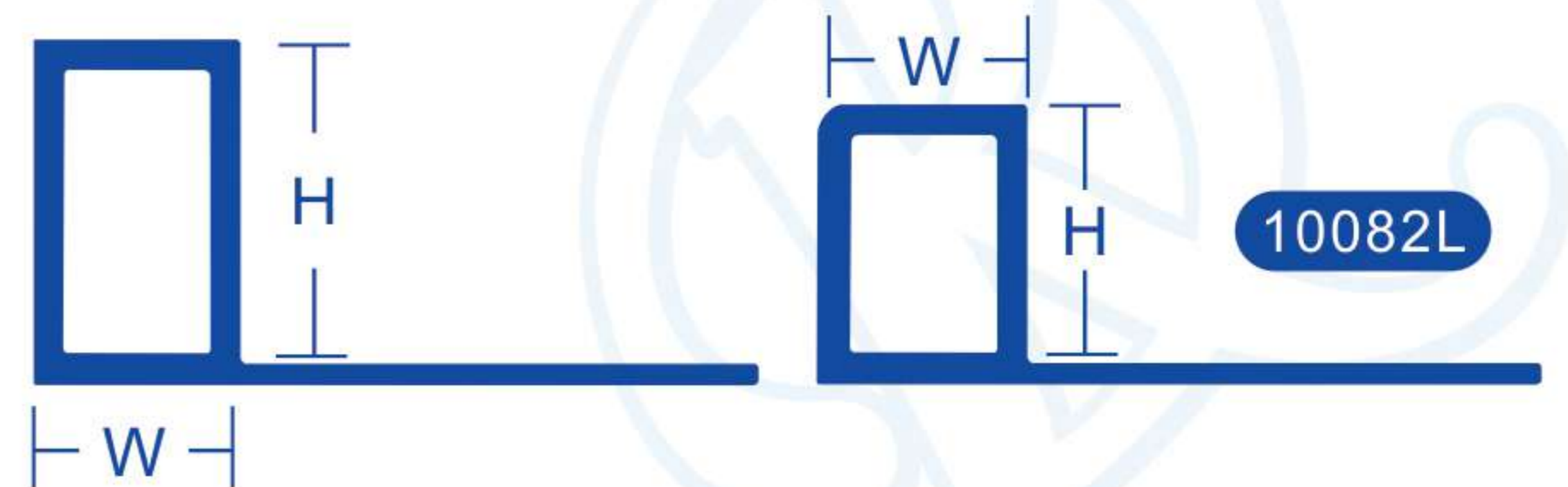

Specifications and Features

- Length: 2.5m.
- Unique Design: Impact-resistant surface, edge-cutting safety design, ensuring no harm to users.
- Aluminum Alloy Construction: Easy to cut and install, with a wide variety of color options.
- All series can be matched with corner components.
- The Silk patterned series is an exclusive patented product (specified codes: M460910, D159364, D159365) Counterfeiting is strictly prohibited!
- Warm Reminder: Avoid using cleaning agents containing strong acids or alkalis, as they may damage the surface. Residual cement or cleaning agents should be promptly rinsed off and dried.
- [Note]: Painted products should not be installed in damp areas or places prone to water accumulation. (Available painted colors: 12 Matte Black, 13 Sandy Black, 18 Ivory, 19 White, 24 Iron Gray)

Color Options

Color Options	12 Matte Black	13 Sandy Black	14 Matte Gold	15 Bright Silver	16 Matte Silver	17 Bright Gold	18 Ivory	19 White	20 Silk Pattern Gold	21 Silk Pattern Silver	22 Silk Pattern Champagne	24 Iron Gray
Model Number												
10082L	✓	✓	⊙	✓	✓	⊙	✓	✓	✗	✗	✗	✓
11081L	✓	✓	⊙	✓	✓	⊙	✓	✓	⊙	✓	✓	✓
12082L	✓	✓	⊙	✓	✓	⊙	✓	✓	⊙	✓	✓	✓
15082L	✓	⊙	⊙	✓	✓	⊙	⊙	⊙	⊙	⊙	⊙	⊙

Legend: ✓ Standard Product ✗ No Color Option Available ⊙ Custom Order Available

Construction Scenarios

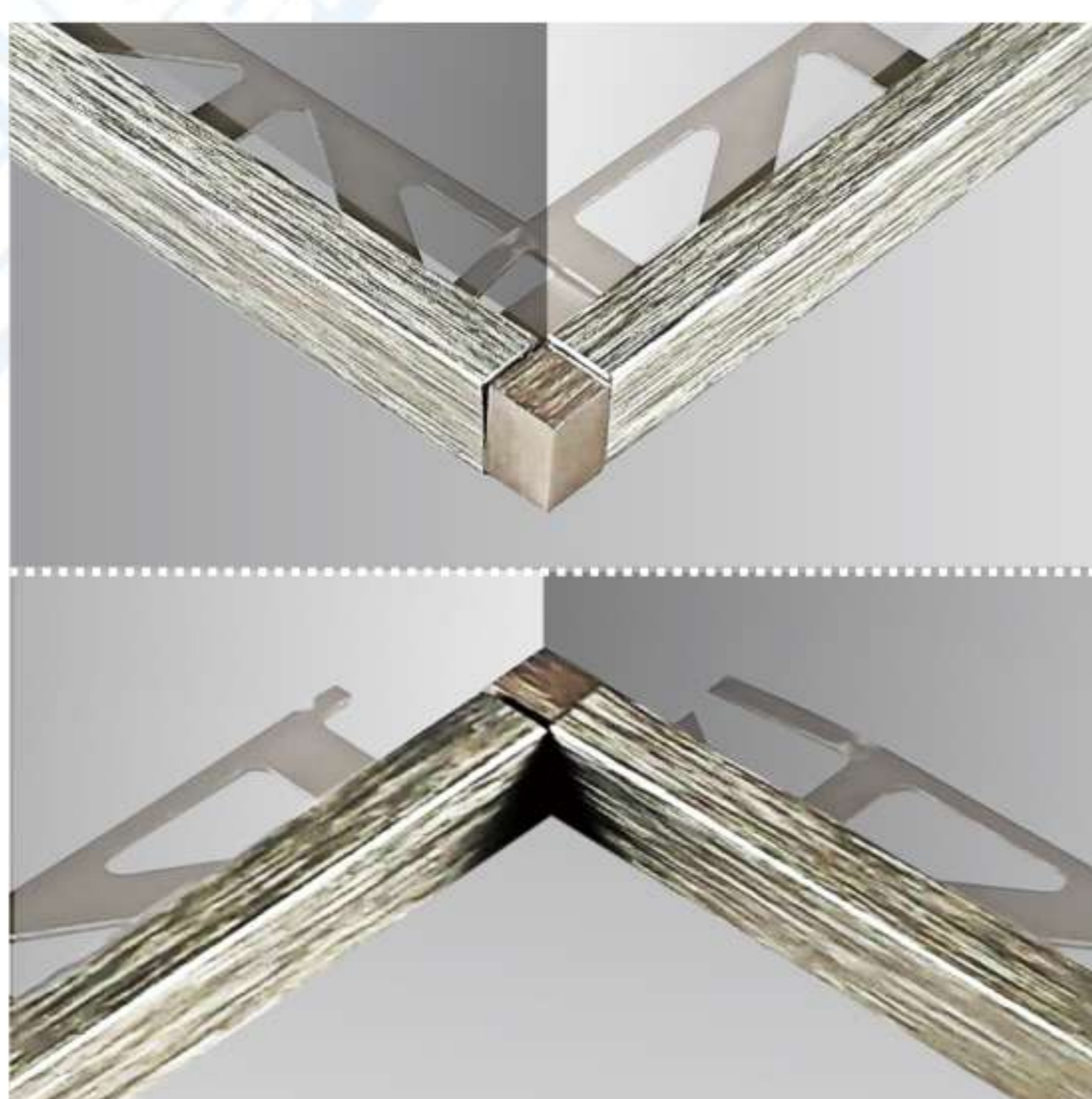

Inner Corner Assembly



Aluminum Alloy Triangle Tile Trim Series



Model	Product Name	H (Height)	W (Width)
08002T	Aluminum Alloy 8mm Triangle Tile Trim	9.0	9.8
11001T	Aluminum Alloy 11mm Triangle Tile Trim	11.0	11.0
12001T	Aluminum Alloy 12.5mm Triangle Tile Trim	12.5	12.5

Unit: mm



Specifications and Features

- Length: 2.5m.
- Exclusive reinforced design, impact-resistant surface, rounded edges for cutting, ensuring safety without injuries.
- Aluminum alloy profile for easy cutting and processing; available in a variety of colors.
- All series can be matched with corner components.
- The Silk patterned series is an exclusive patented product (Patent Numbers: M460910, D159364, D159365). Counterfeiting is strictly prohibited!
- Warm Reminder: Avoid using cleaning agents containing strong acids or alkalis, as they may damage the surface. Residual cement or cleaning agents should be promptly rinsed off and dried.
- [Note]: Painted products should not be installed in damp areas or places prone to water accumulation. (Available painted colors: 12 Matte Black, 13 Sandy Black, 18 Ivory, 19 White, 24 Iron Gray)

Color Options

Color Options	12 Matte Black	13 Sandy Black	14 Matte Gold	15 Bright Silver	16 Matte Silver	17 Bright Gold	18 Ivory	19 White	20 Silk Pattern Gold	21 Silk Pattern Silver	22 Silk Pattern Champagne	24 Iron Gray
Model Number												
08002T	⊙	⊙	⊙	✓	✓	⊙	✓	✓	✗	✗	✗	✓
11001T	⊙	⊙	⊙	✓	✓	⊙	✓	✓	✗	✗	✗	✓
12001T	⊙	⊙	⊙	✓	✓	⊙	✓	✓	✗	✗	✗	✓

Legend: ✓ Standard Product ✗ No Color Option Available ⊙ Custom Order Available

Construction Scenarios

Outer Corner Assembly

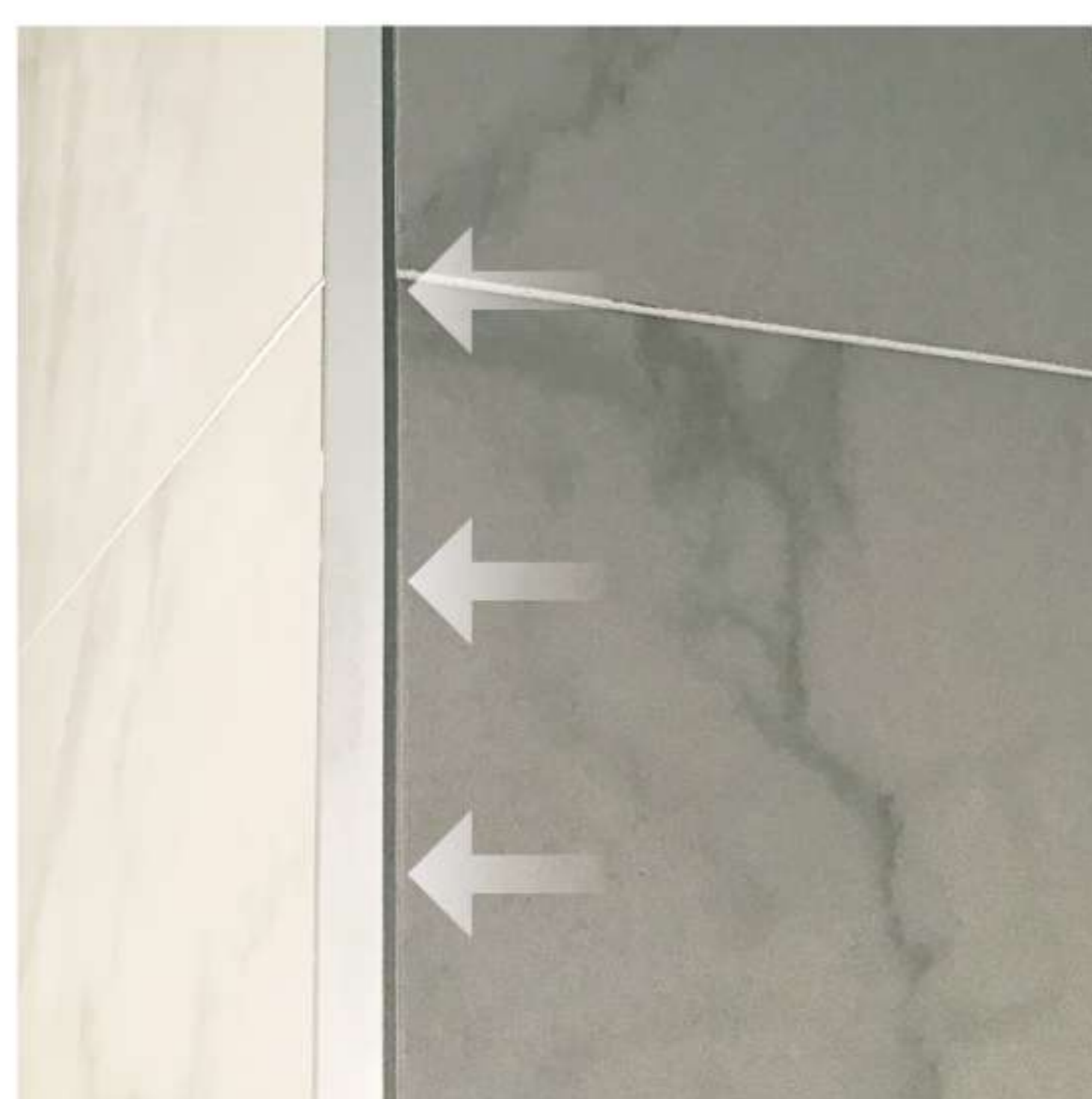
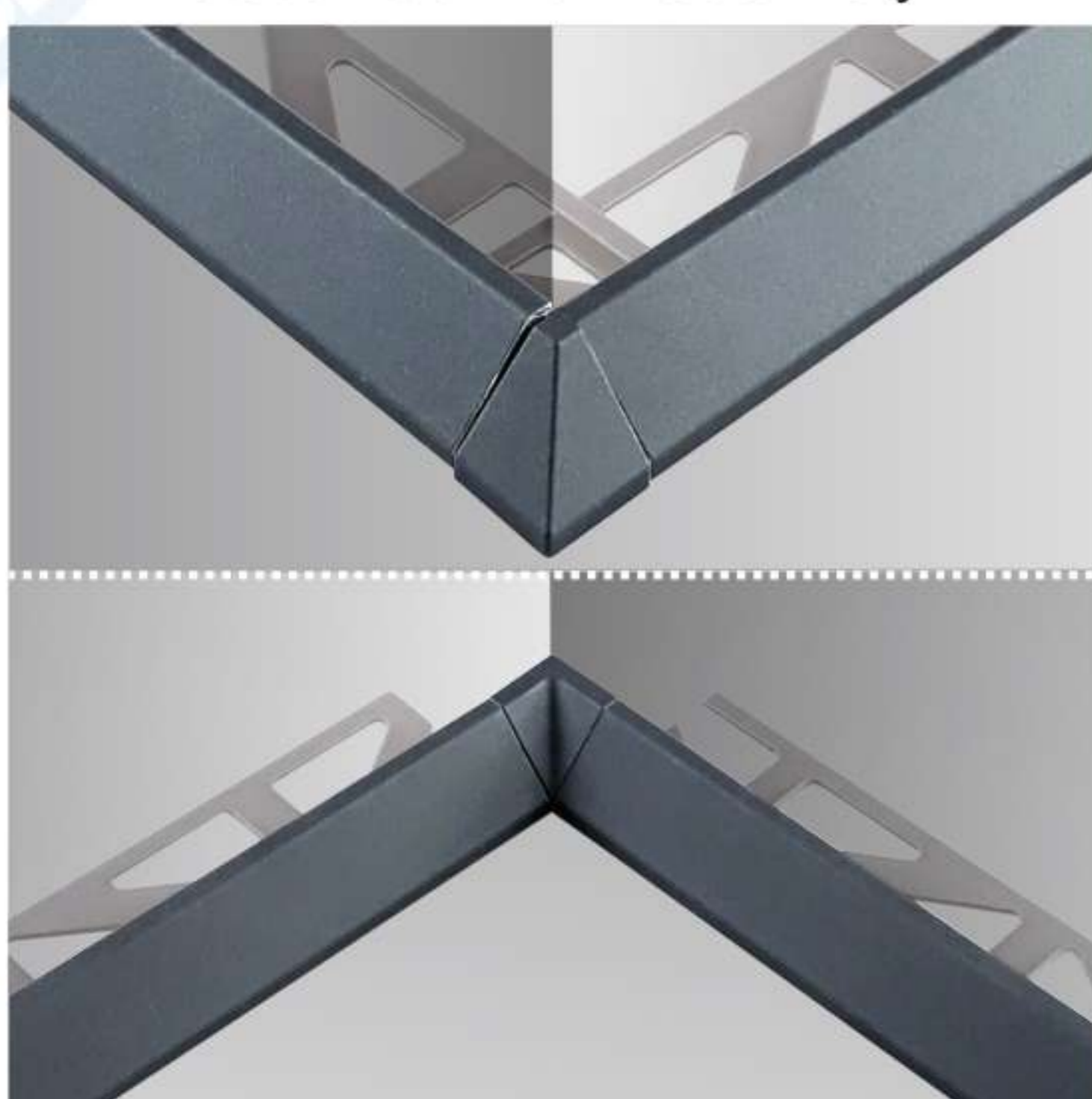

Inner Corner Assembly



Aluminum Narrow Edge Square Trim Series



Model	Product Name	H (Height)	W (Width)
11051L	Aluminum 11mm Narrow Square Trim	10.9	4.9
12051L	Aluminum 12.5mm Narrow Square Trim	12.9	4.9
15051L	Aluminum 15mm Narrow Square Trim	16.0	5.0
25051L	Aluminum 25mm Narrow Square Trim	26.2	5.0

Unit: mm

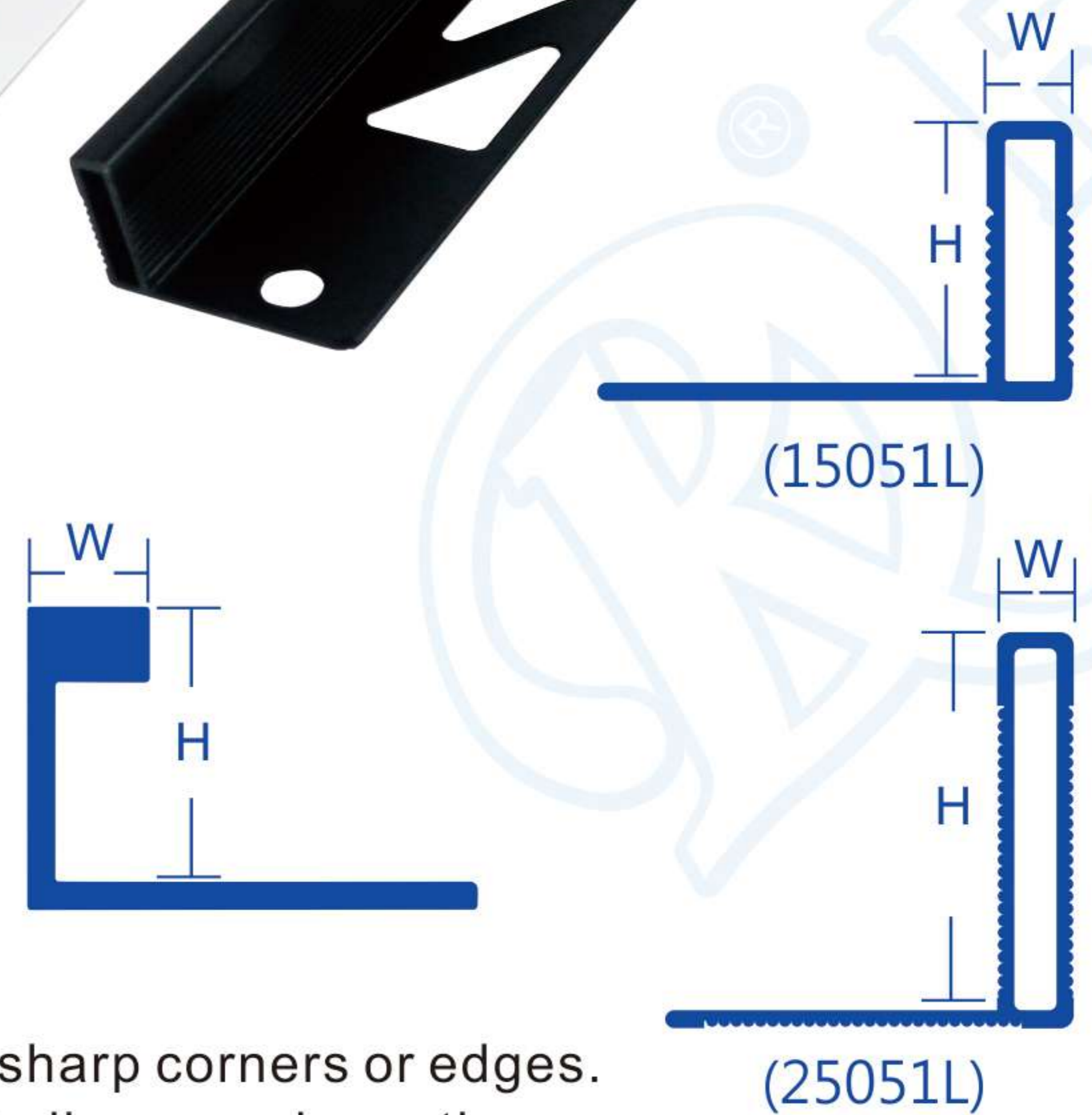

Specifications and Features

- Length: 2.5m.
- Unique Design: Safety-enhanced design to prevent injury from sharp corners or edges.
- Material: Made from aluminum alloy, easy to cut and install, with diverse color options.
- Versatility: Suitable for different applications and can be styled as needed (refer to application examples).
- Cleaning Instructions: Avoid using cleaning agents containing acid or corrosive substances. Residue or dirt may damage the surface coating. Clean and dry promptly.
- [Note:] Painted products are not suitable for wet or humid areas.
Painted color options: 12 Matte Black, 13 Sandy Black, 18 Ivory, 19 White

Color Options

Color Options	12 Matte Black	13 Sandy Black	14 Matte Gold	15 Bright Silver	16 Matte Silver	17 Bright Gold	18 Ivory	19 White
Model Number								
11051L	⊙	⊙	⊙	✓	✓	⊙	✓	✓
12051L	⊙	⊙	⊙	✓	✓	⊙	✓	✓
15051L	✓	⊙	⊙	⊙	⊙	⊙	⊙	⊙
25051L	✓	⊙	⊙	⊙	⊙	⊙	⊙	⊙

Legend: ✓ Standard Product ✗ No Color Option Available ⊙ Custom Order Available

Construction Scenarios





Aluminum Alloy Equal-Sided Square Edge Trim Series



Model	Product Name	H (Height)	W (Width)
04052L	Aluminum Alloy 4mm Equal-Sided Square Trim	4.2	5.0
06071L	Aluminum Alloy 6.5mm Equal-Sided Square Trim	6.5	7.3
09091L	Aluminum Alloy 9mm Equal-Sided Square Trim	9.0	9.8
11111L	Aluminum Alloy 11mm Equal-Sided Square Trim	11.0	11.8
12122L	Aluminum Alloy 12.5mm Equal-Sided Square Trim	12.5	13.3

Unit: mm

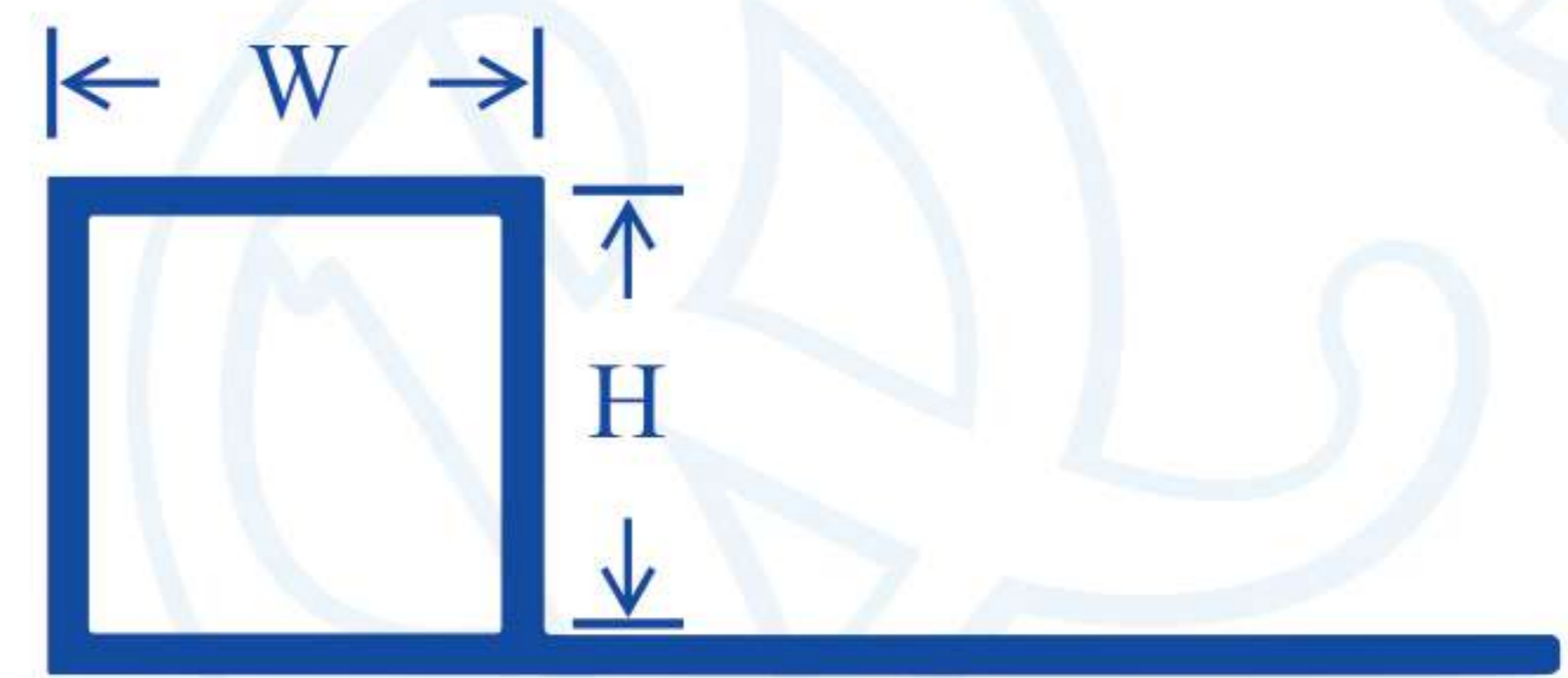

Specifications and Features

- Length: 2.5m.
- Exclusive Reinforced Design: Impact-resistant surface, rounded corners, and smooth edges to ensure user safety.
- Material: Made from aluminum alloy, easy to cut and install, with a wide variety of color options.
- All series can be matched with corner components.
- The Silk patterned series is an exclusive patented product (Patent Numbers: M460910, D159364, D159365); counterfeiting is prohibited!
- Cleaning Reminder: Avoid using cleaning agents with acidic or corrosive ingredients. Residual dirt or solutions may damage the surface; clean and dry promptly.
- [Note:] Painted products are not suitable for wet or humid areas. Painted colors include: 12 (Matte Black), 13 (Sandy Black), 18 (Ivory), and 19 (White).

Color Options

Color Options	12 Matte Black	13 Sandy Black	14 Matte Gold	15 Bright Silver	16 Matte Silver	17 Bright Gold	18 Ivory	19 White	20 Silk Pattern Gold	21 Silk Pattern Silver	22 Silk Pattern Champagne
Model Number											
04052L	⊙	⊙	⊙	⊙	✓	⊙	⊙	✓	✗	✗	✗
06071L	✓	✓	⊙	✓	✓	⊙	✓	✓	✗	✗	⊙
09091L	✓	✓	⊙	✓	✓	⊙	✓	✓	⊙	⊙	⊙
11111L	✓	⊙	⊙	✓	✓	⊙	⊙	⊙	⊙	✓	✓
12122L	✓	⊙	⊙	✓	✓	⊙	⊙	⊙	⊙	✓	✓

Legend: ✓ Standard Product ✗ No Color Option Available ⊙ Custom Order Available

Construction Scenarios

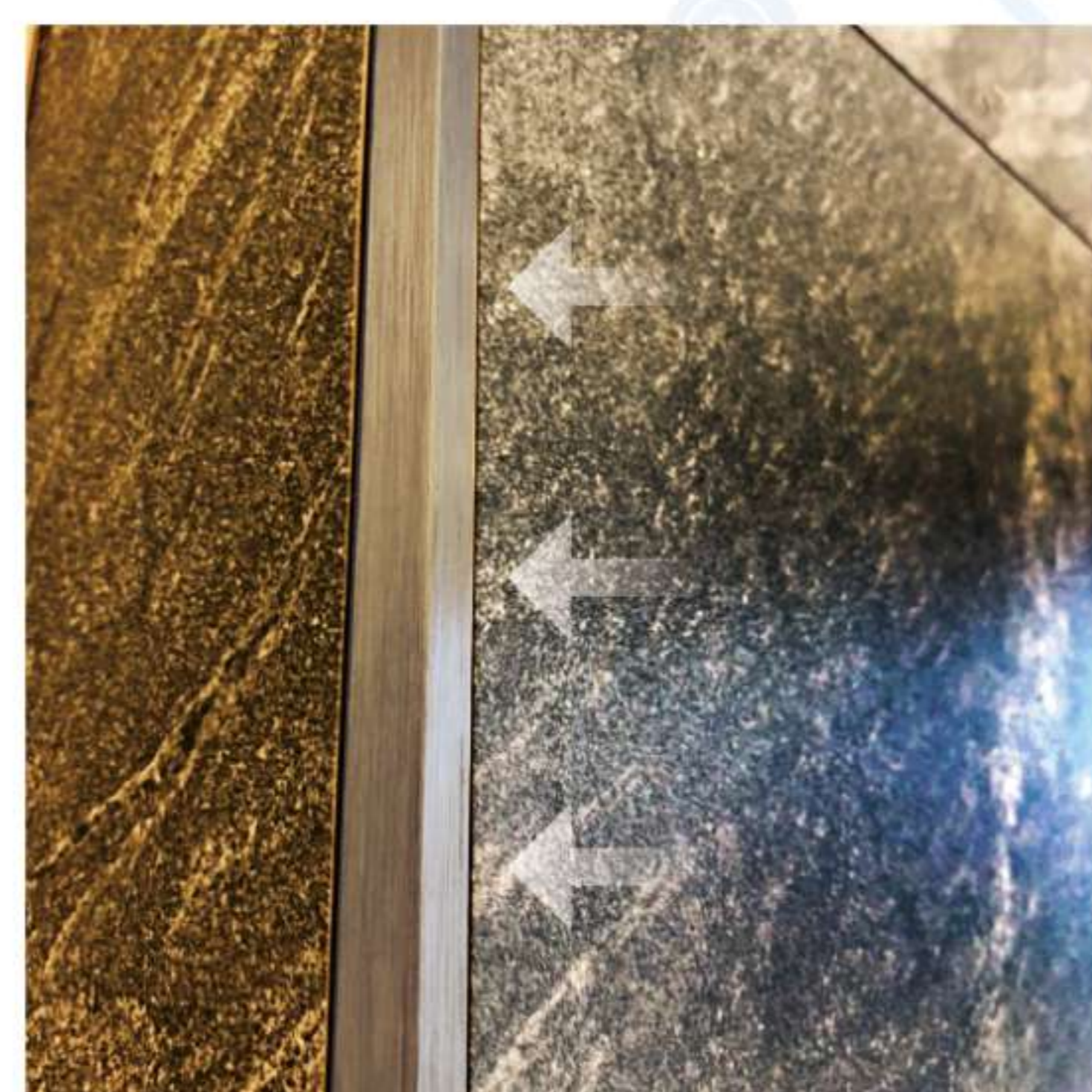
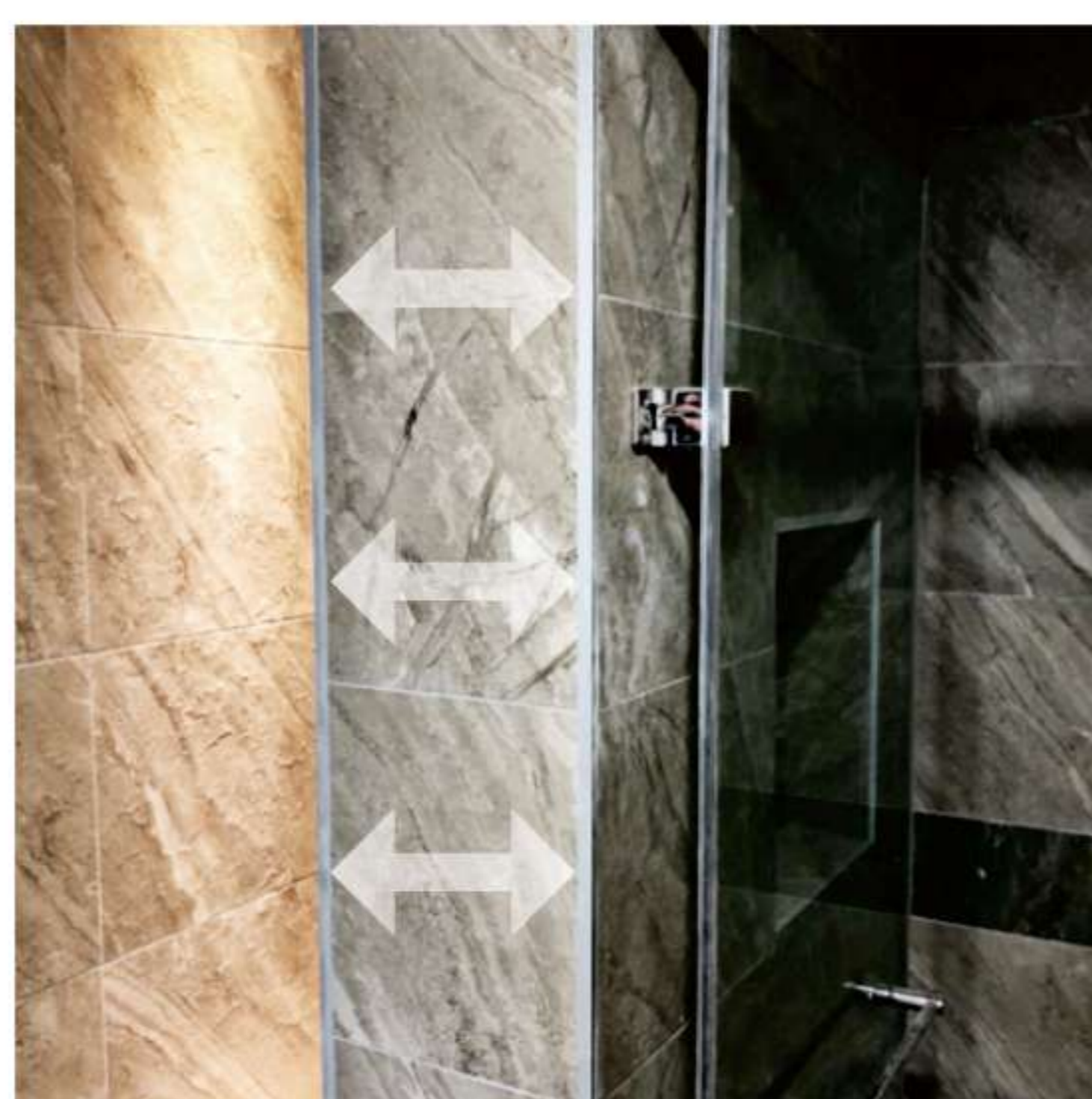
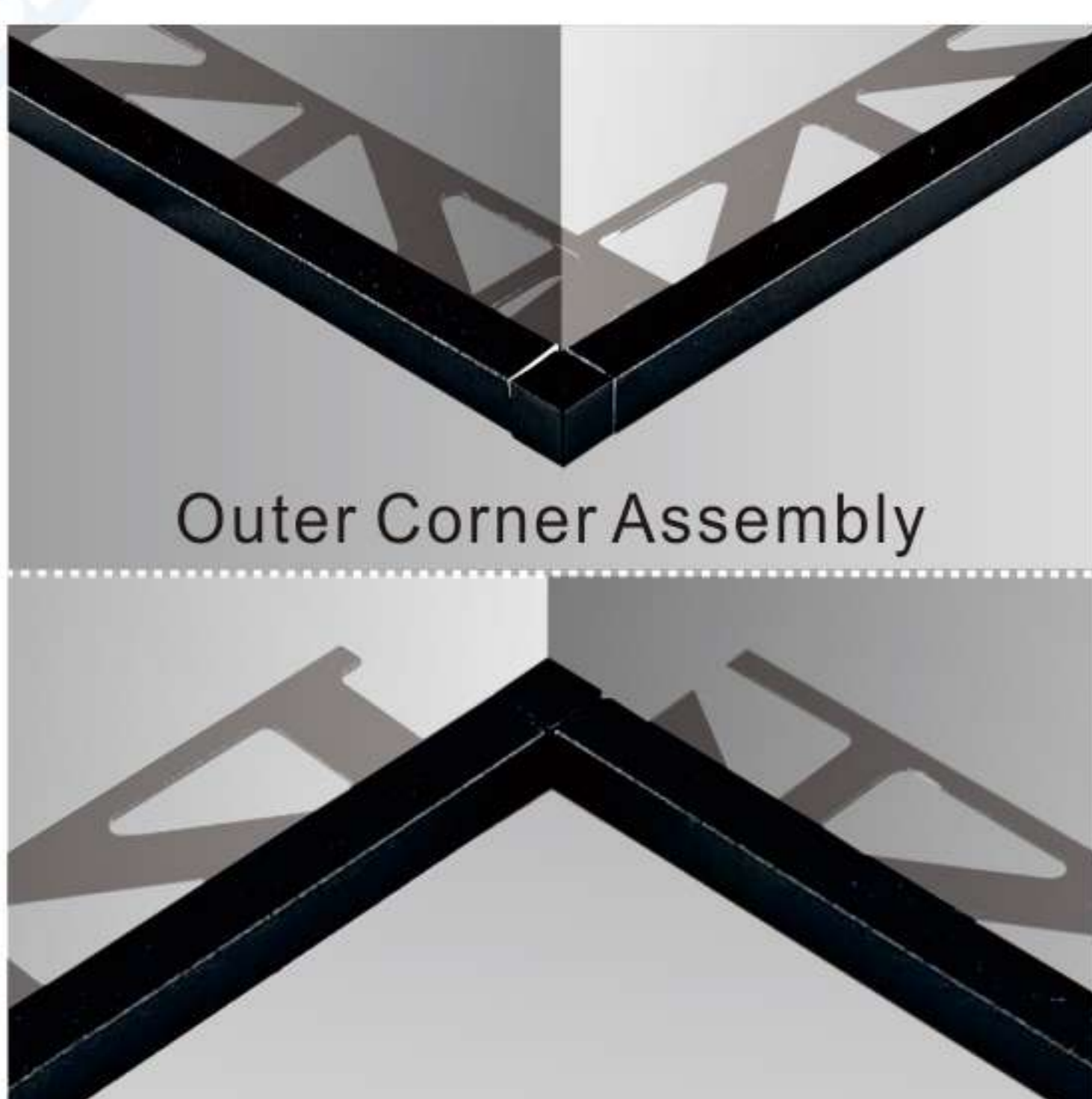



Aluminum Alloy M-Type Edge Trim Series

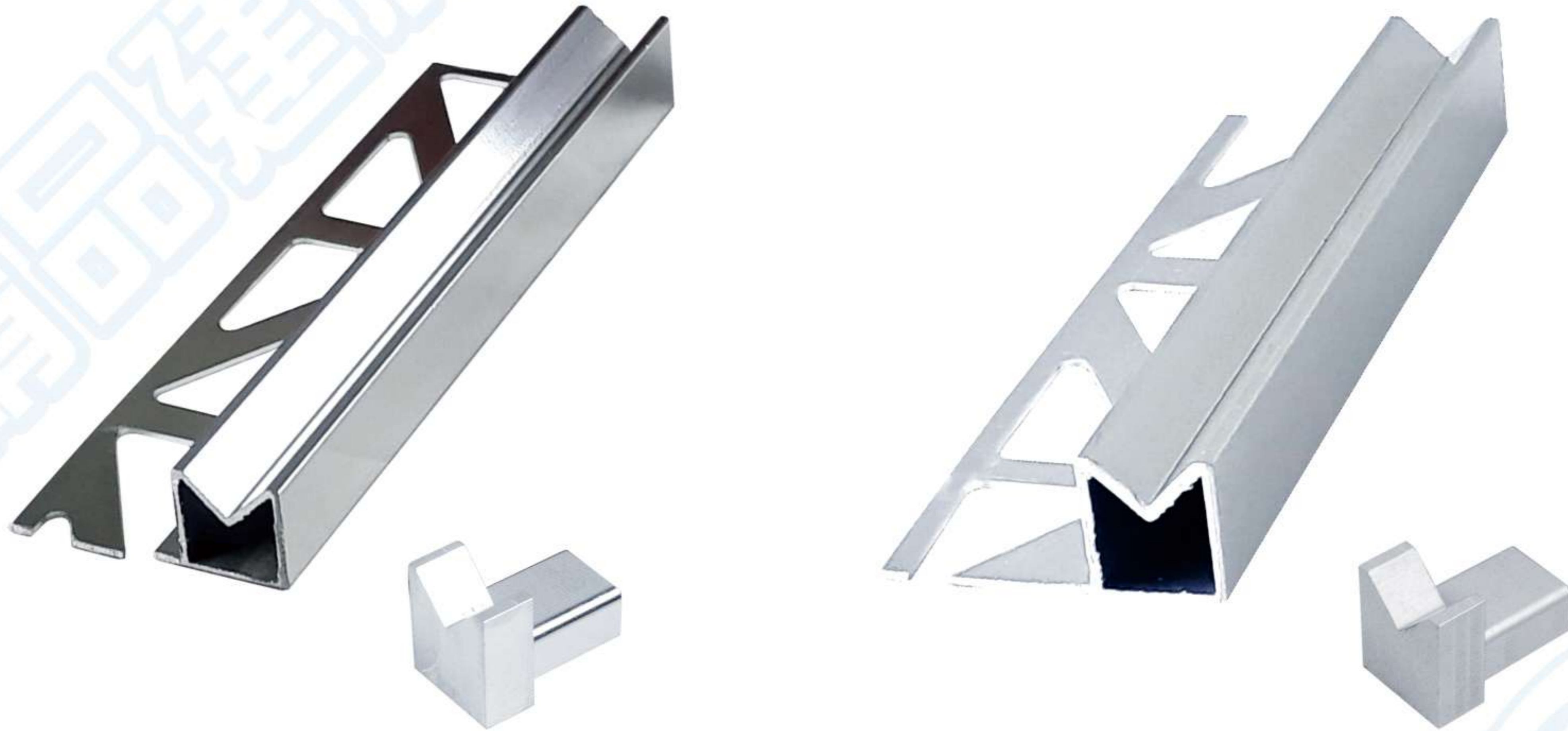

Unit: mm

Model	Product Name	H (Height)	W (Width)
11121M	Aluminum Alloy 11mm M-Type Edge Trim	11.0	12.0
12121M	Aluminum Alloy 12.5mm M-Type Edge Trim	12.5	12.0

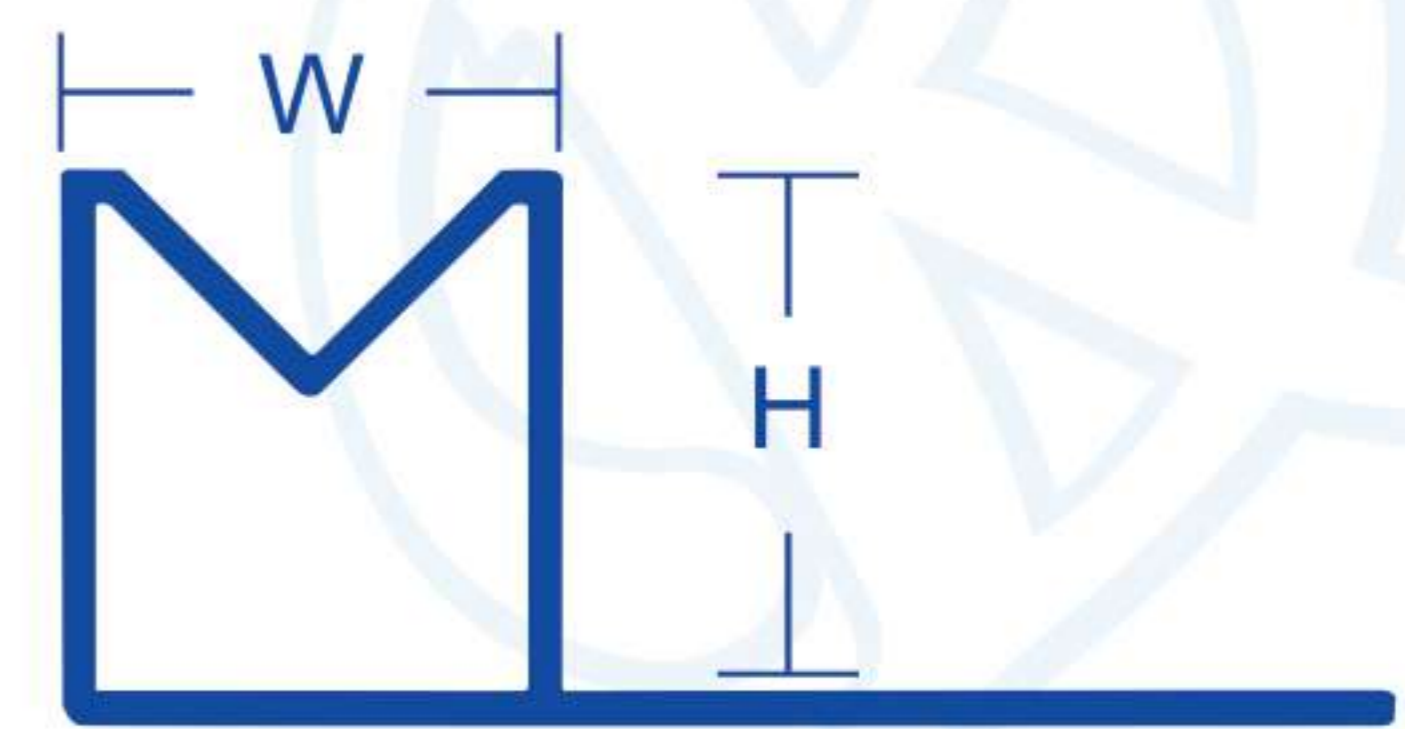

Specifications and Features

- Length: 2.5m.
- Exclusive Design: Rounded corner and smooth edge design to ensure safety.
- Material: Aluminum alloy, easy to cut and install, with a variety of color options.
- Application: Installed between tiles to replace traditional back-beveling, ensuring quality and easy cleaning.
- Additional Use: Can be installed on exterior walls as a guideboard for backsplash use, offering effective protection and a stylish appearance.
- Accessories: Full range of corner connectors and end caps are available.
- Cleaning Reminder: Avoid using acidic or corrosive cleaning agents. Residue such as mud or cleaning solution may damage the surface. Clean and dry promptly.
[Note:] Painted products are not suitable for humid or wet areas.
Painted color options: 12 (Matte Black), 13 (Sandy Black), 18 (Ivory), 19 (White).

Color Options

Color Options	12 Matte Black	13 Sandy Black	14 Matte Gold	15 Bright Silver	16 Matte Silver	17 Bright Gold	18 Ivory	19 White
Model Number								
11121M	⊙	⊙	⊙	✓	✓	⊙	⊙	⊙
12121M	⊙	⊙	⊙	✓	✓	⊙	⊙	⊙

Legend: ✓ Standard Product ✗ No Color Option Available ⊙ Custom Order Available

Construction Scenarios





Aluminum Alloy Bullnose L- shaped Edge Trim Series

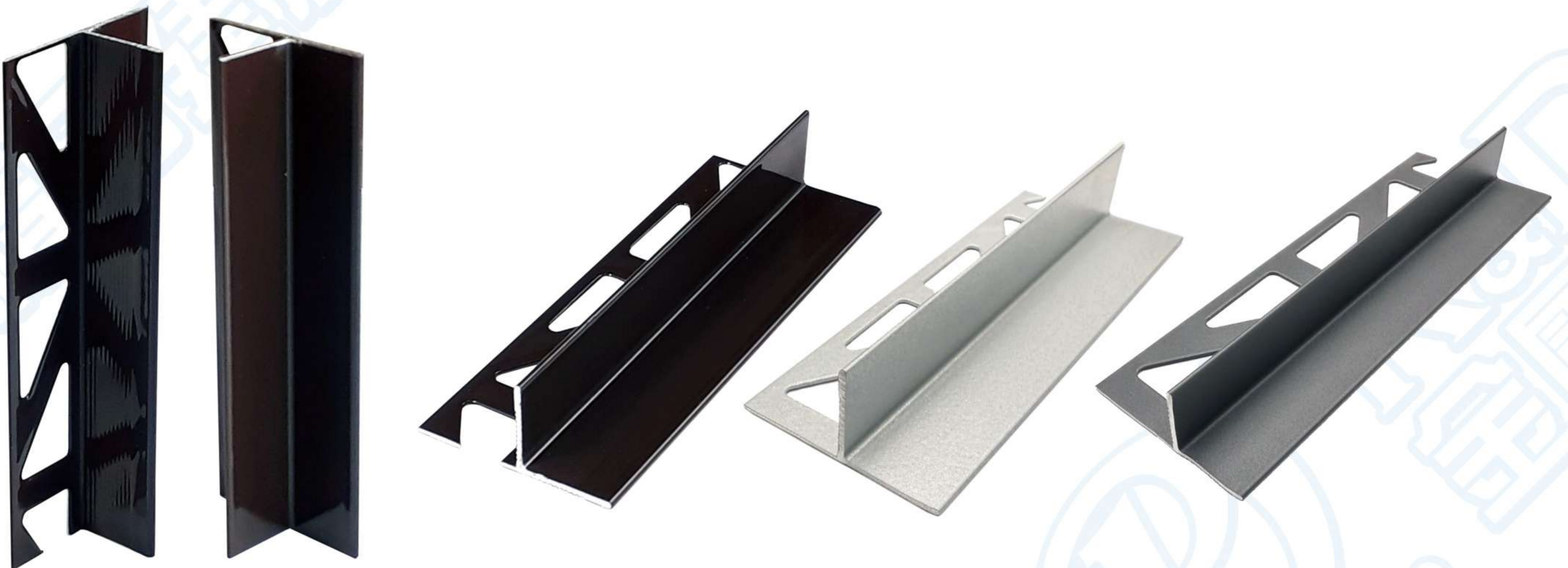

Unit: mm

Model	Product Name	H (Height)	W (Width)
17171L	Aluminum Alloy Bullnose 15mm L-Type Edge Trim	17.0	17.0
13131L	Aluminum Alloy Bullnose 12mm L-Type Edge Trim	13.0	13.0

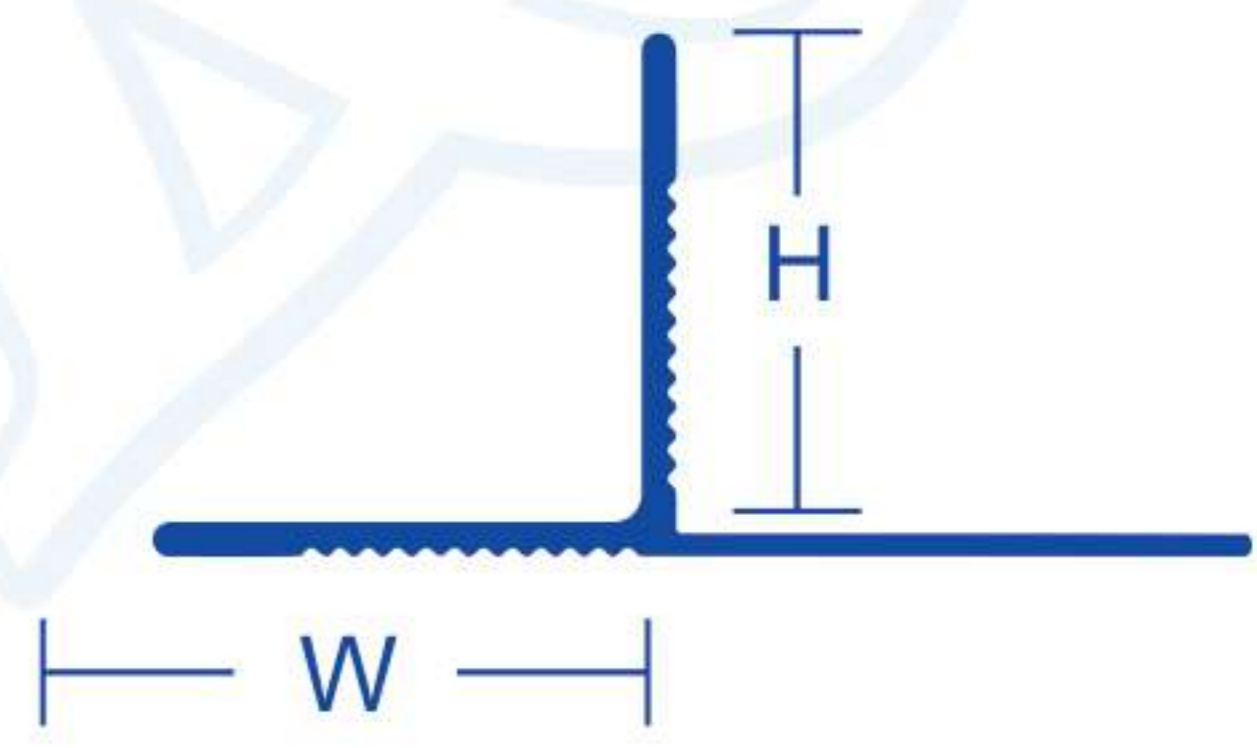

Specifications and Features

- Length: 2.5m.
- Exclusive Design: Rounded corner and smooth edge design to ensure safety.
- Material: Aluminum alloy, easy to cut and install, with diverse color options!
- Bullnose Design: Features a concave curved surface with distinct texture variations on each side.
- Cleaning Reminder: Avoid using acidic or corrosive cleaning agents. Residue such as mud or cleaning solutions may damage the surface. Clean and dry promptly.
- [Note:] Painted products are unsuitable for wet or humid areas or places prone to water accumulation. Painted color options: 10 (Coffee), 11 (Silver Gray), 12 (Matte Black), 13 (Sandy Black), 18 (Ivory), 19 (White), 24 (Iron Gray)

Color Options

Color Options	10 Coffee	11 Silver Gray	24 Iron Gray
Model Number			
17171L	✓	✓	✓
13131L	✓	✓	✓

Legend: ✓ Standard Product ✗ No Color Option Available ⊕ Custom Order Available

Construction Scenarios

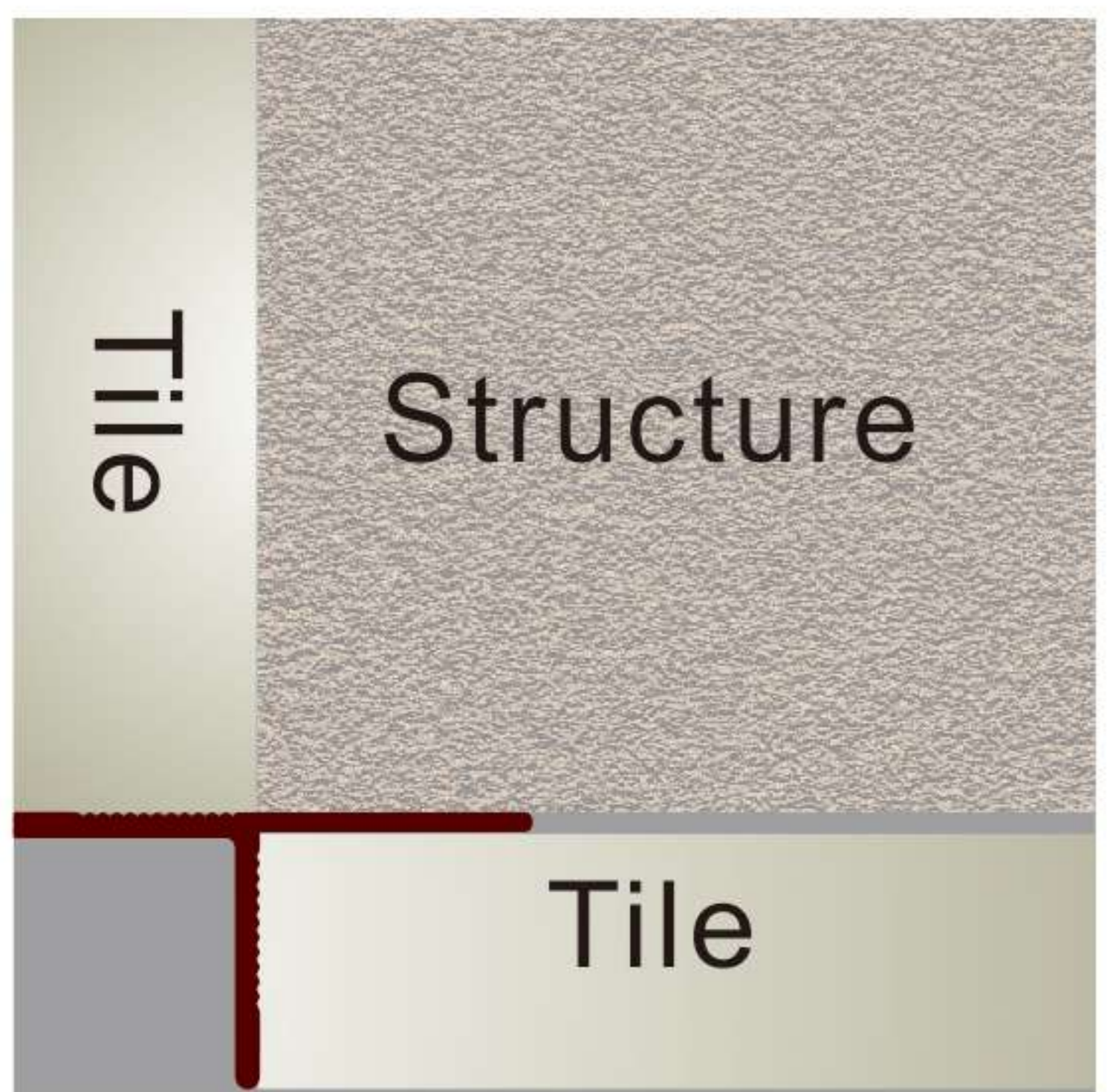



Aluminum Alloy L-Type Trim Series



Unit: mm

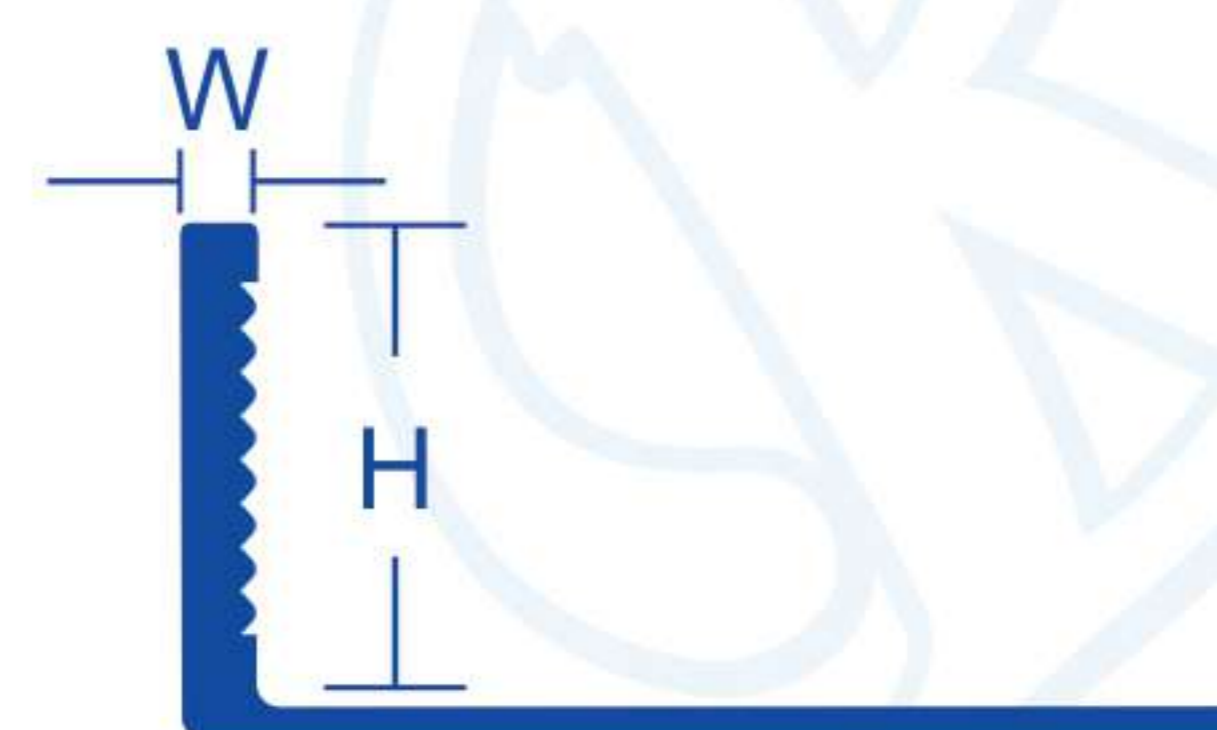

Model	Product Name	H (Height)	W (Width)
12021L	Aluminum Alloy 12mm L-Type Trim	2.0	11.0
13021L	Aluminum Alloy 13mm L-Type Trim	2.0	12.5



Specifications and Features

- Length: 2.5 meters
- Made of aluminum alloy with surface treatment, easy to cut and install, and available in a variety of colors.
- Can be used for wall or floor tile trim.
- Suitable for transitions between tiles and stone materials.
- Reminder: Avoid using cleaning products containing strong acidic or alkaline ingredients. Residual cement or cleaners may damage the surface—please clean and dry promptly.
- [Note]: Coated trims should not be installed in damp areas or where water is likely to accumulate. (Coated color: 12 Matt Black)

Color Options

Color Options	12 Matte Black	16 Matte Silver
Model Number		
12021L	✓	✓
13021L	✓	✓

Legend: ✓ Standard Product
 ✗ No Color Option Available
 ⊙ Custom Order Available

Construction Scenarios

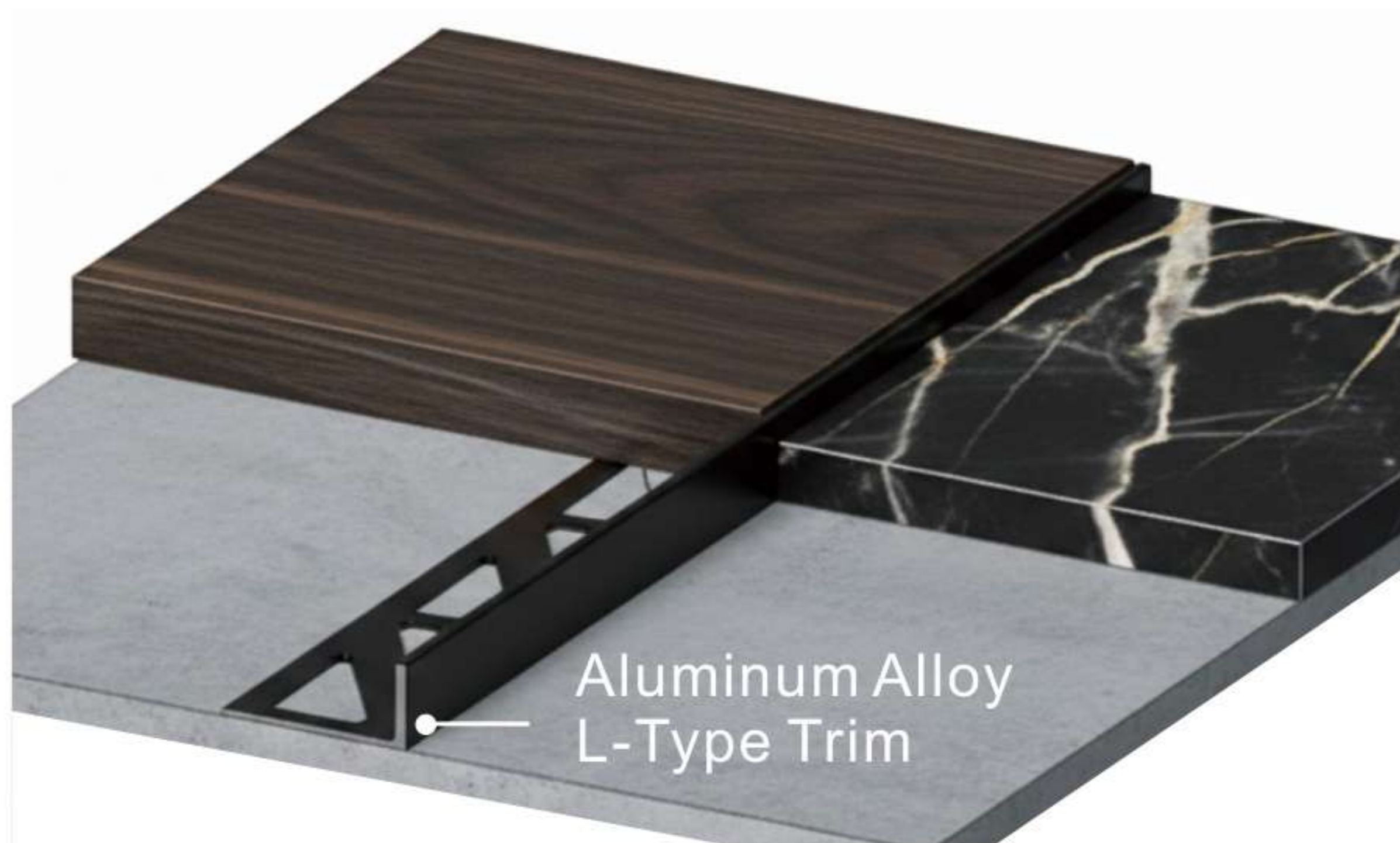
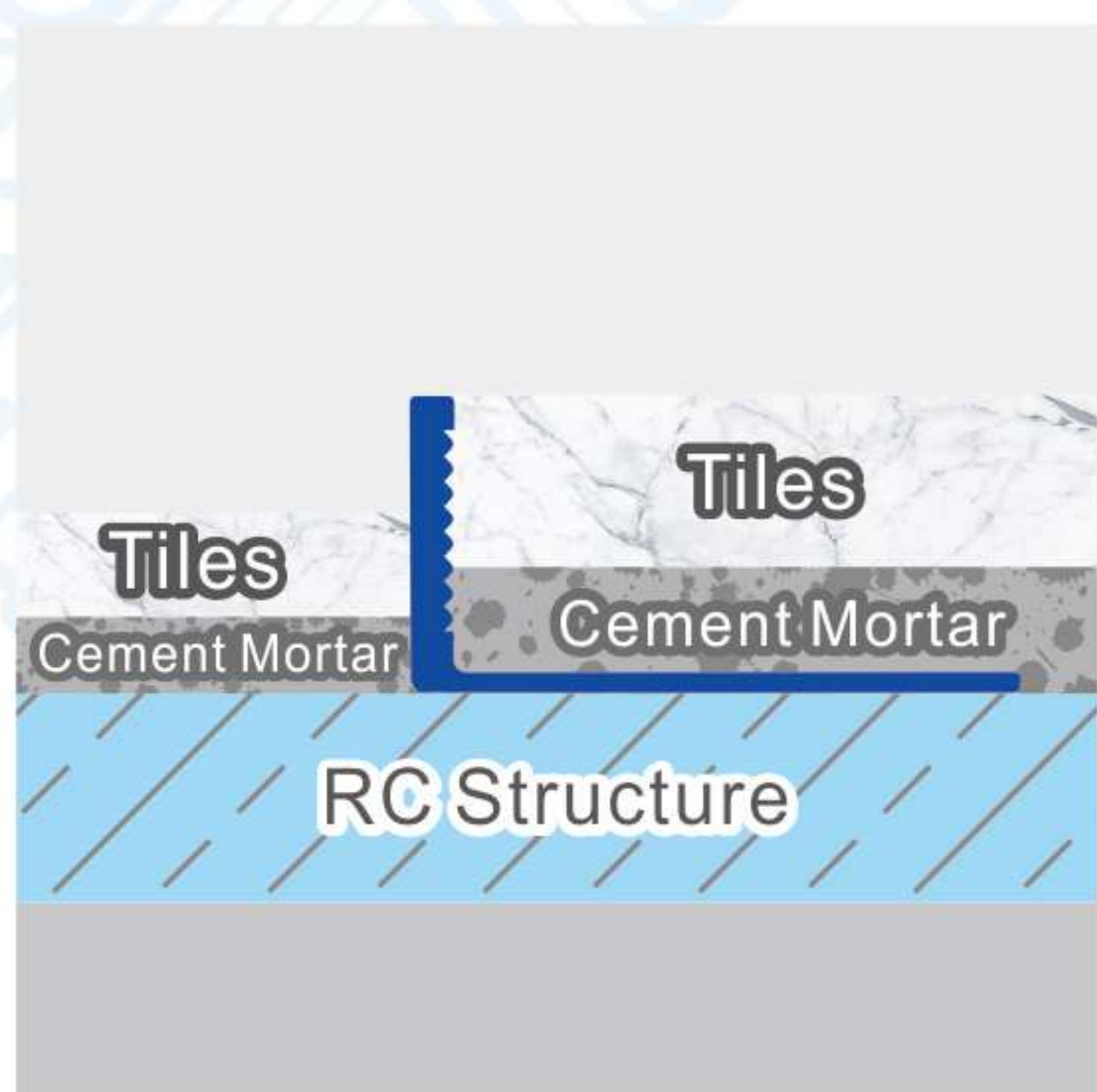



Aluminum Alloy Line Edge Deco Trim Series



Model	Product Name	H (Height)	W (Width)	Unit: mm
12031P	Aluminum Alloy 12mm Line Edge Deco Trim	12.5	3.0	

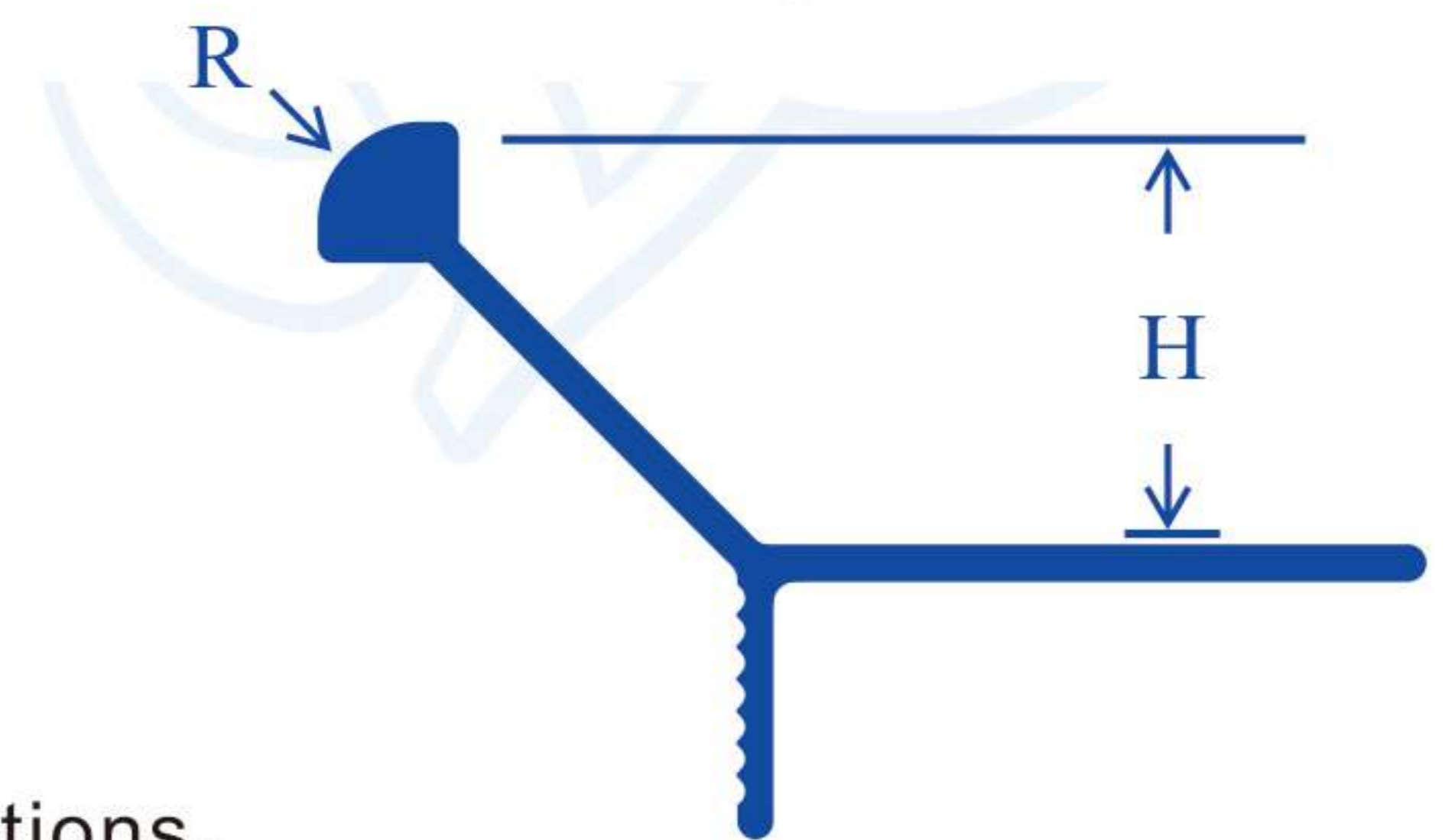

Specifications and Features

- Length: 2.5m.
- Material: Aluminum alloy, easy to cut and install, with diverse color options.
- Rounded Corners: Smooth rounded edges ensure safety and prevent injury during handling.
- Exclusive Design: Protects the back bevel of tiles and sharp edges, adding extra safety.
- Beveled Trim: Combines aesthetics with installation convenience.
- Cleaning Reminder: Avoid using acidic or corrosive cleaning agents. Residue such as mud or cleaning solutions may damage the surface. Clean and dry promptly.
- [Note:] Painted products are unsuitable for humid or wet areas or places prone to water accumulation. Painted color options: 12 (Matte Black), 13 (Sandy Black), 18 (Ivory), 19 (White).

Color Options

Color Options	16 Matte Silver	19 White
Model Number		
12031P	✓	✓

Legend: ✓ Standard Product ✗ No Color Option Available ⊕ Custom Order Available

Construction Scenarios

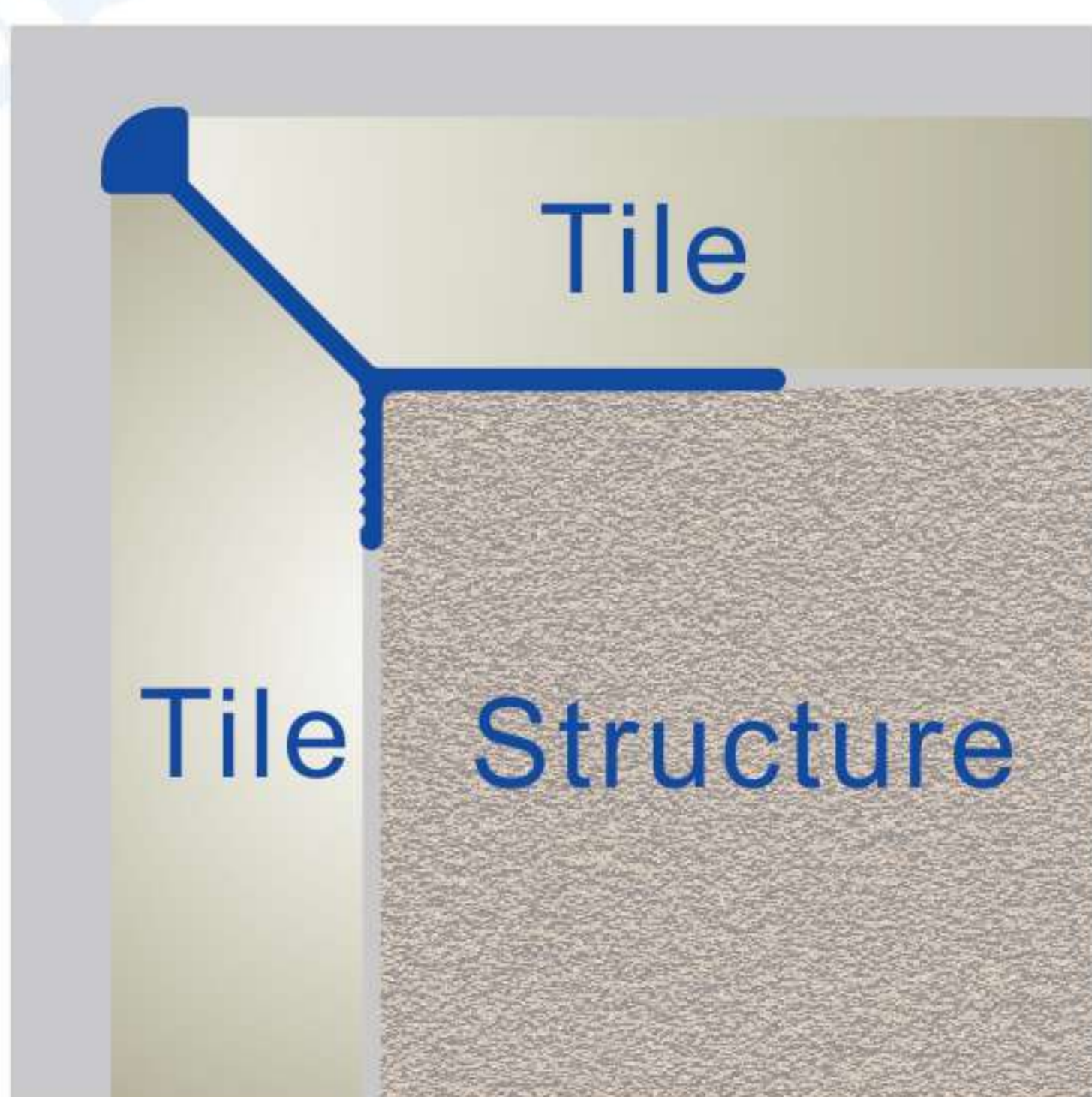



Aluminum Alloy T-Type Trim Series

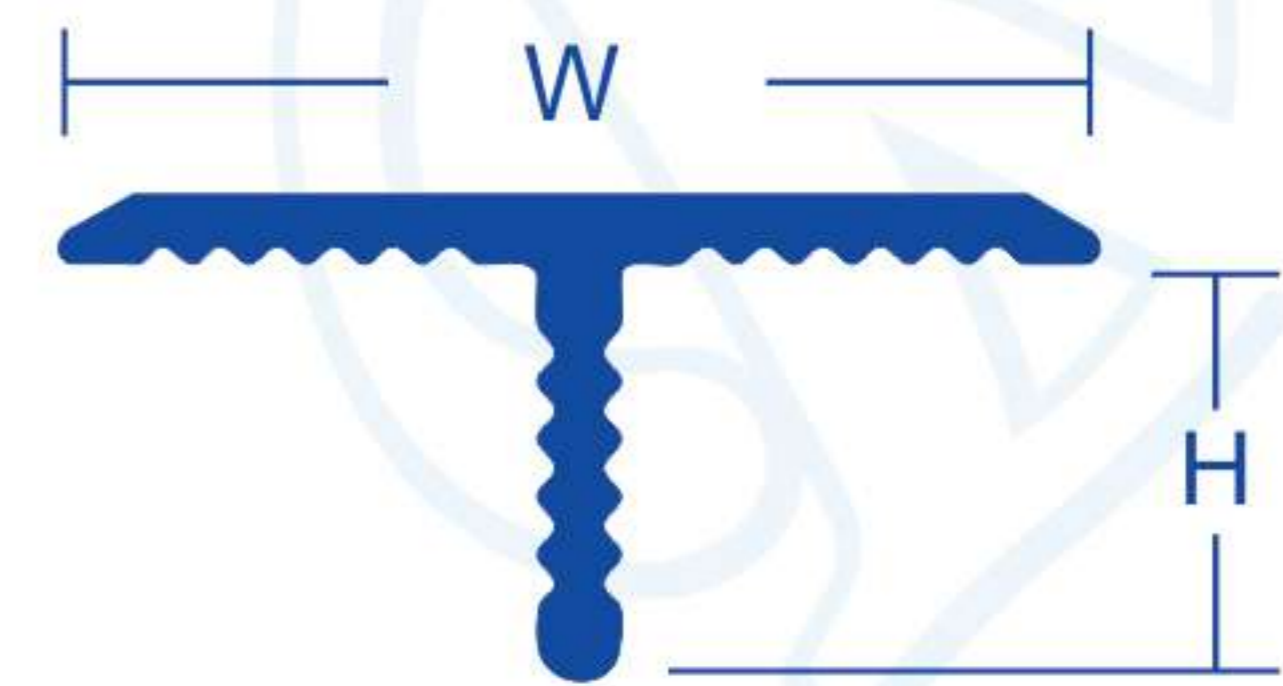

Model	Product Name	H (Height)	W (Width)	Unit: mm
15061T	Aluminum Alloy 15mm T-Type Trim	6.0	15.0	

Specifications and Features

- Length: 2.5m.
- The aluminum alloy T-type trim has an exterior that is easy to cut and install, with a variety of colors available for customization.
- Suitable for use as a trim between wall tiles and ceiling panels (refer to the sample image).
- Can also be used as an expansion joint between the wall and floor materials (refer to the sample image).
- Avoid using strong acidic or alkaline cleaners, as they may damage the surface. Rinse thoroughly if residue from such cleaners remains.

Color Options

Color Options	15 Bright Silver
Model Number	
15061T	✓

Legend: ✓ Standard Product ✗ No Color Option Available ⊕ Custom Order Available

Construction Scenarios

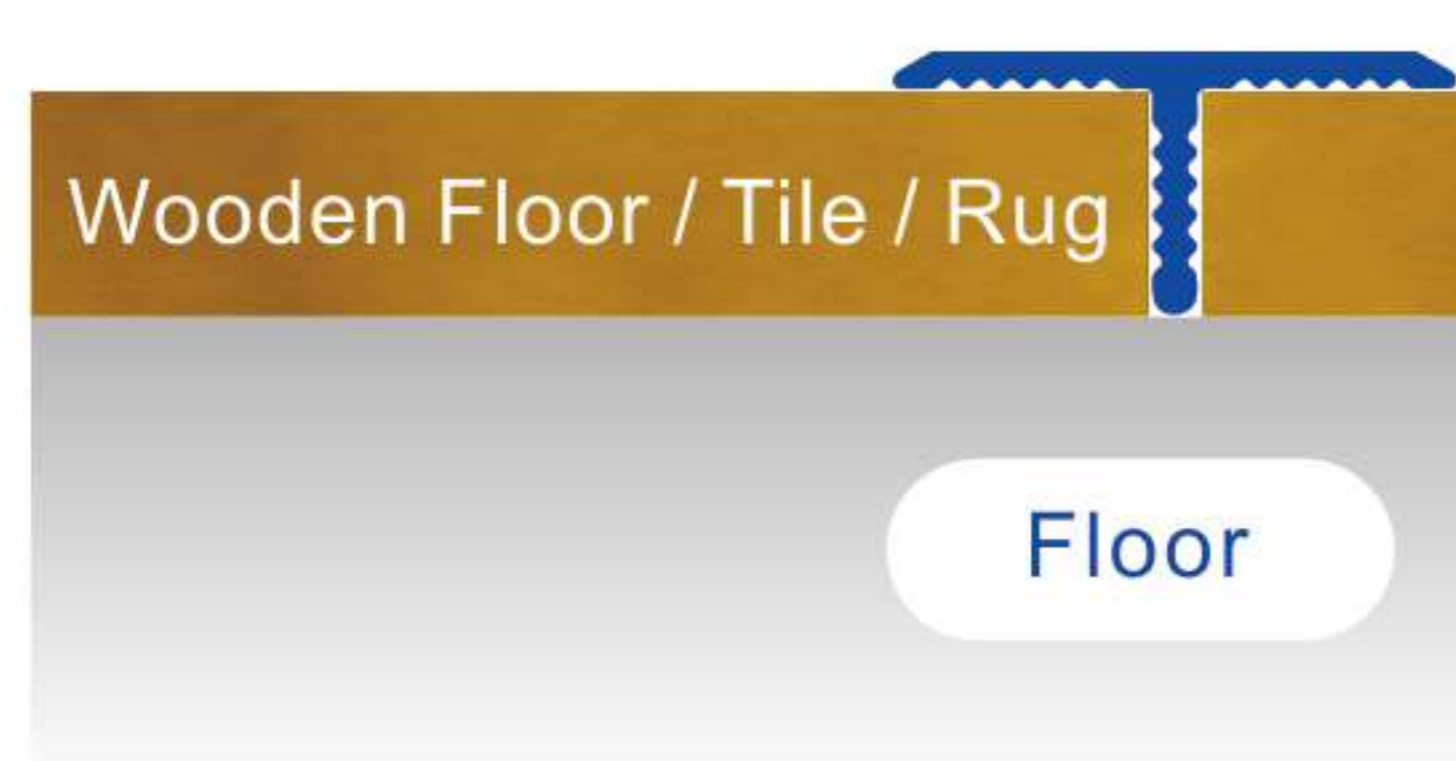
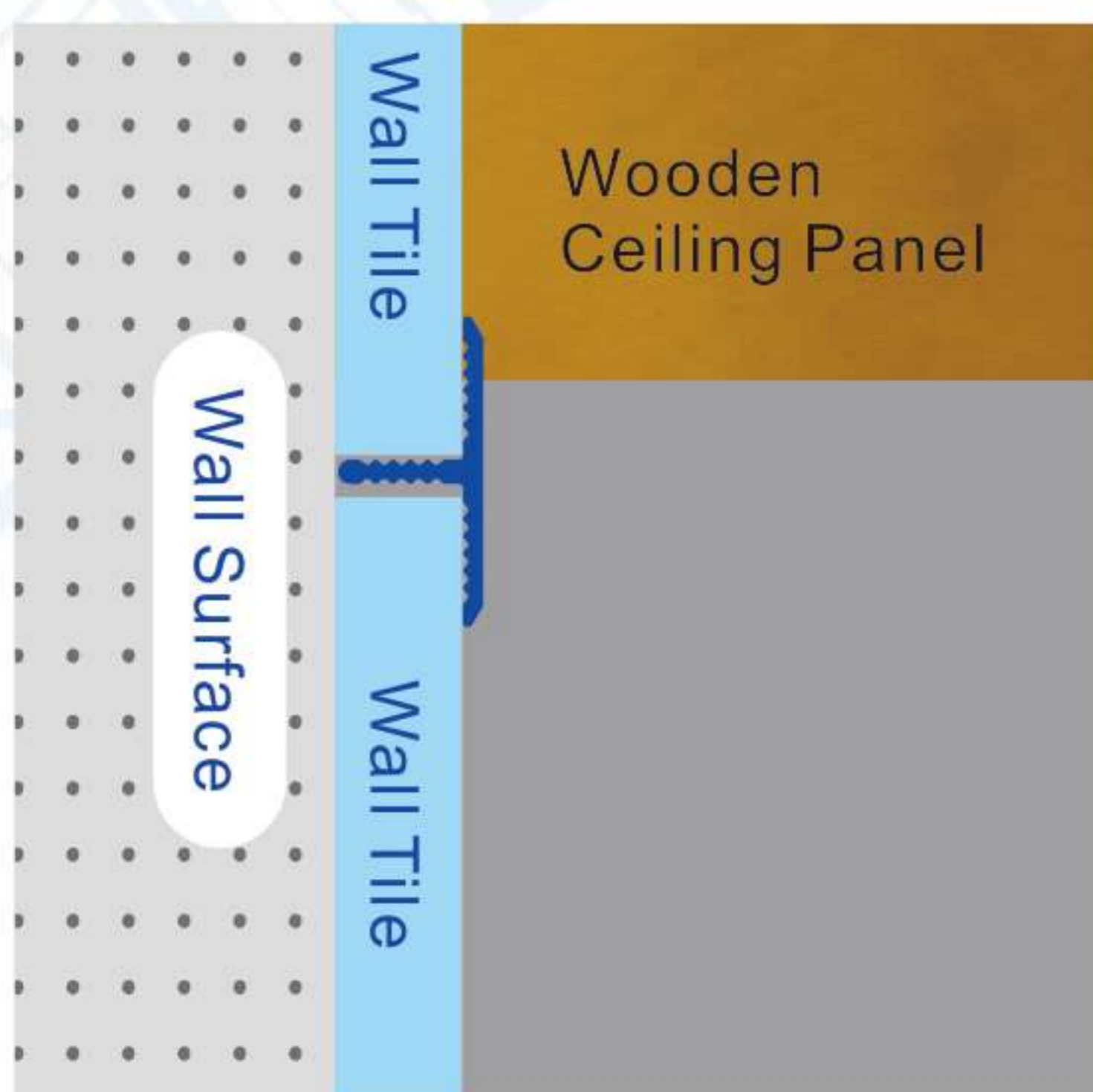



Aluminum Alloy U or □ shape Trim Series

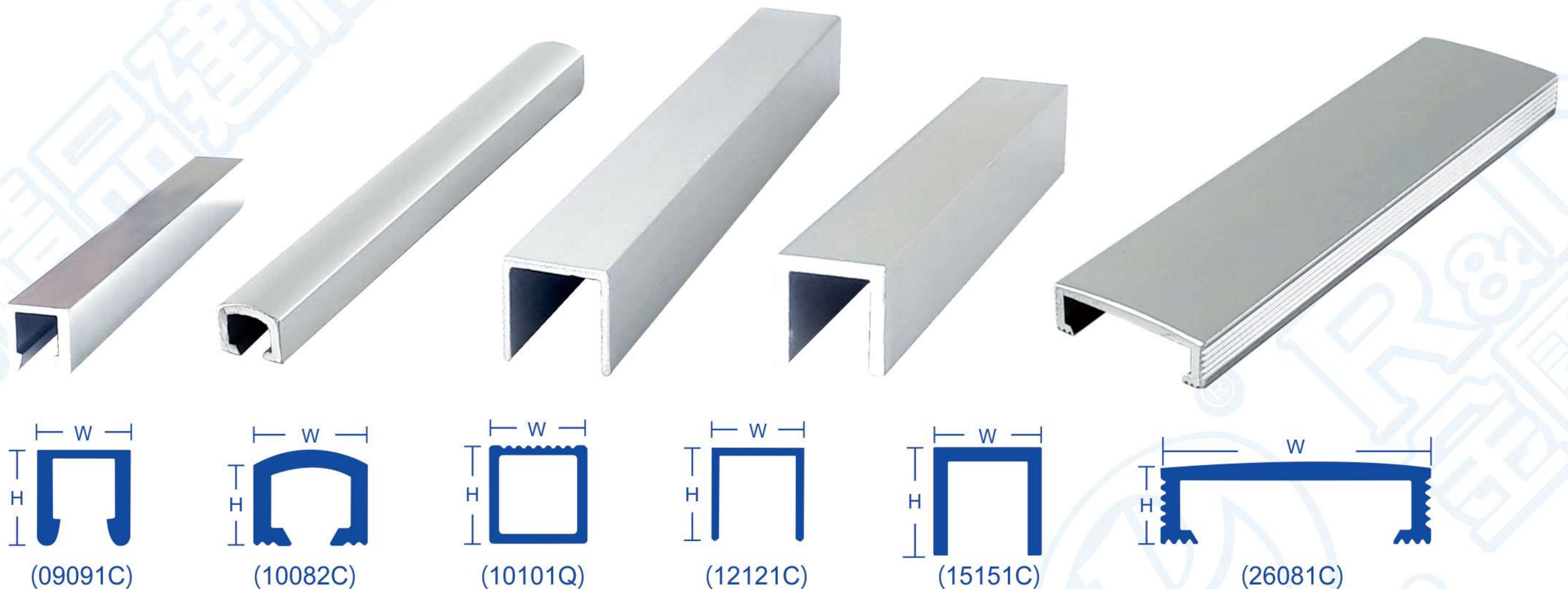

Model	Product Name	H (Height)	W (Width)
10101Q	Aluminum Alloy 10mm □ Shape Trim	10.0	10.0
26081C	Aluminum Alloy 26mm U Shape Trim	8.0	26.0
10082C	Aluminum Alloy 10mm U Shape Trim	8.2	9.8
09091C	Aluminum Alloy 9.5mm U Shape Trim	9.8	9.5
12121C	Aluminum Alloy 12mm U Shape Trim	12.7	12.7
15151C	Aluminum Alloy 15mm U Shape Trim	15.0	15.0

Unit: mm

Specifications and Features

- Length: 2.5m.
- The aluminum alloy design is precise, easy to cut, and convenient for installation, with a variety of color options available.
- 10mm □ Shape Edge Trim: Suitable for flat or inear textured pattern decorative edges. The inear textured pattern side can also serve as an anti-slip strip when installed facing outward.
- 9.5mm U Shape Edge Trim: Suitable for flat or channeled decorative edges. The channeled side, when installed outward, can be used as a hook and is also suitable for embedding glass frames.
- Note: Do not use cleaning agents with high hydrochloric acid content. Residual cement or cleaning agents may corrode the surface. Please clean promptly.

Color Options

Color Options	14 Matte Gold	15 Bright Silver	16 Matte Silver	17 Bright Gold
Model Number				
10101Q	⊙	✗	✓	⊙
26081C	⊙	✓	✓	⊙
10082C	⊙	✓	✓	⊙
09091C	⊙	✓	✓	⊙
12121C	⊙	✗	✓	⊙
15151C	⊙	✗	✓	⊙

Legend: ✓ Standard Product
 ✗ No Color Option Available
 ⊙ Custom Order Available

Construction Scenarios

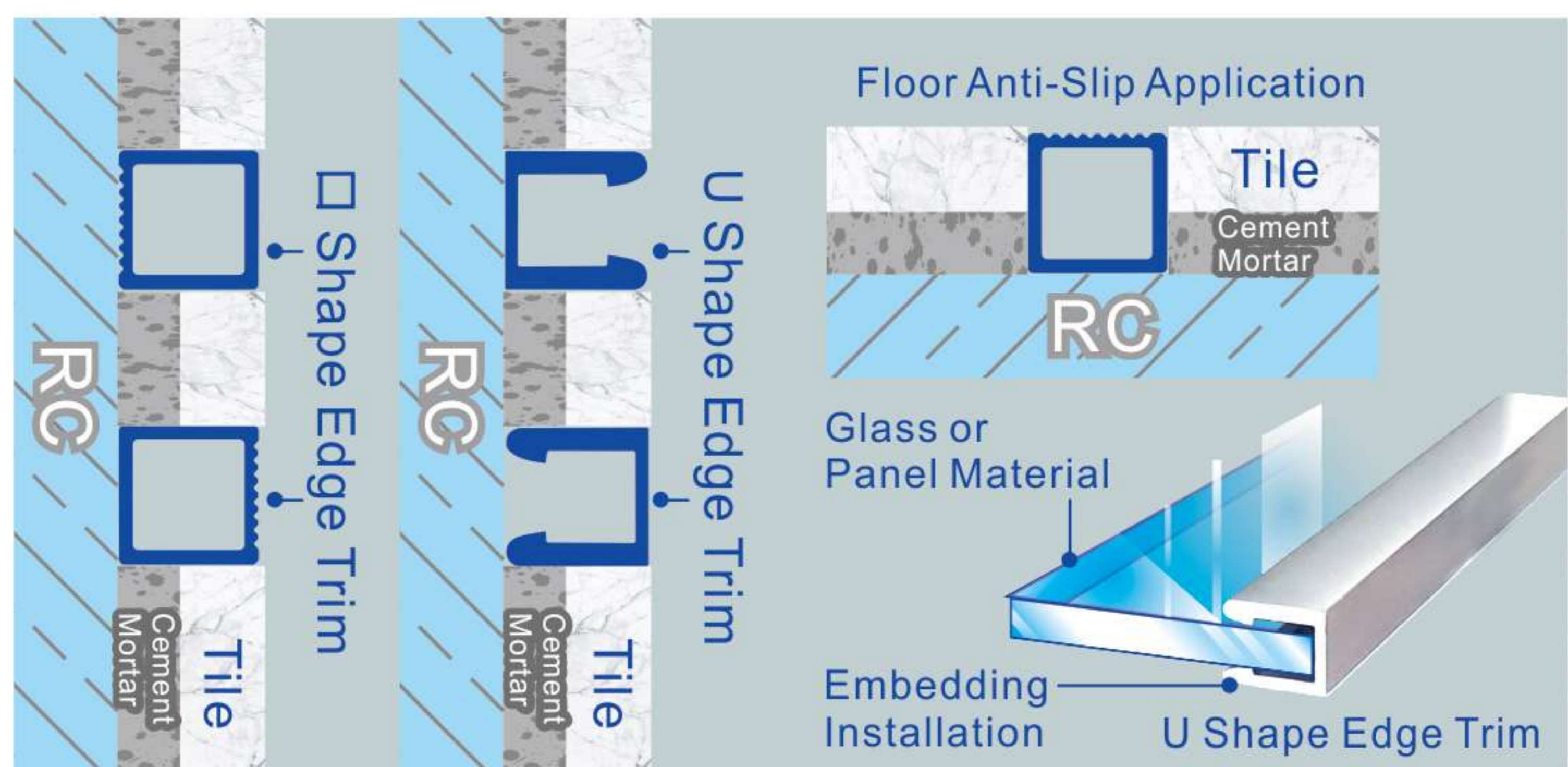



Aluminum Alloy Internal Corner Trim Series



Model	Product Name	H (Height)	W (Width)	Unit: mm
11121R	Aluminum Alloy 11mm Inner Corner Trim	11.0	22.0	

Specifications and Features

- Length: 2.5m.
- Exclusive safety design with rounded edges, preventing hand injuries.
- Aluminum alloy molding for easy cutting and installation, with a variety of color options.
- Ideal for inner corner repair in bathrooms and cleaning areas (e.g., food factories, laboratories, and hospitals), seamlessly connecting walls and floors.
- The entire series comes with optional corner and joint accessories for compatibility.
- Reminder: Avoid using cleaning agents containing strong acids or alkalis. Residual cement or cleaning agents may damage the surface, so clean and dry promptly.

Color Options

Color Options	16 Matte Silver	26 champagne
Model Number		
11121R	✓	✓

Legend: ✓ Standard Product
 ✗ No Color Option Available
 ⊙ Custom Order Available

Construction Scenarios

Outer Corner Assembly



Inner Corner Assembly



Post-Installation Recessed Skirting Board Series



(50202F)

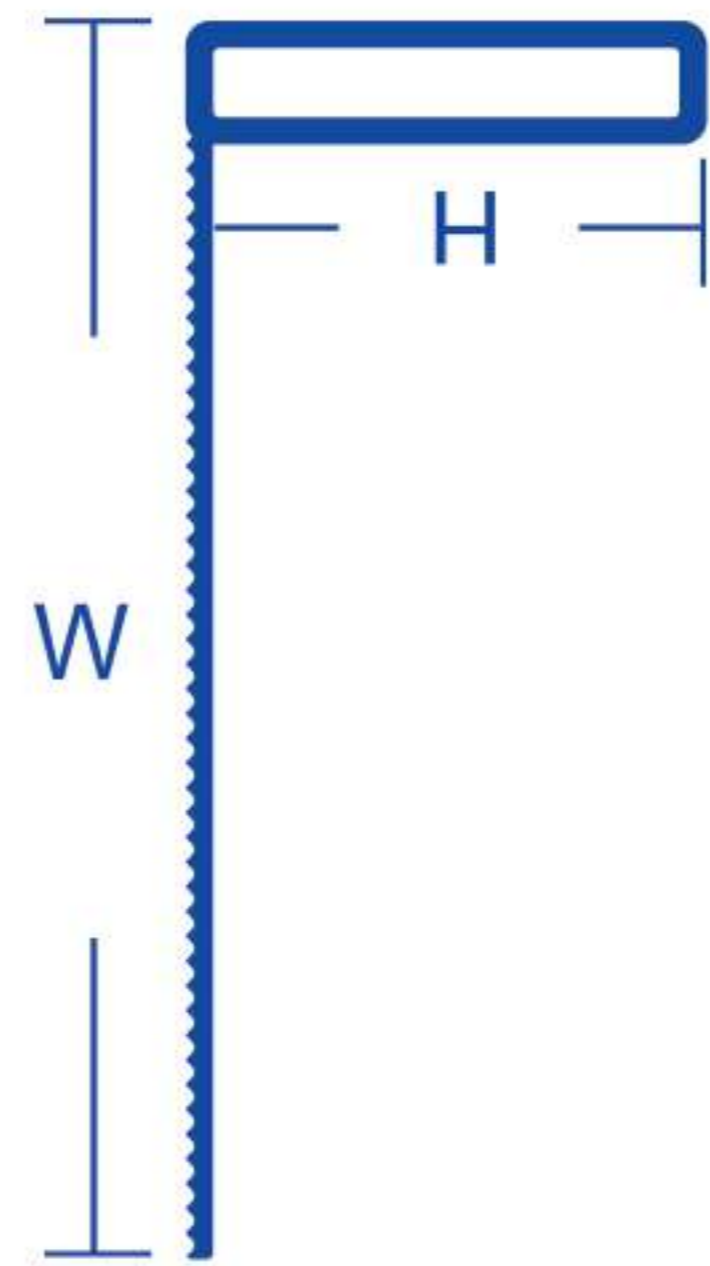

(50202F)



(35141F)



(35141F)

Model	Product Name	H (Height)	W (Width)	Unit: mm
50202F	Post-Installation 20mm Recessed Skirting Board	50.0	20.0	
35141F	Post-Installation 35mm Recessed Skirting Board	35.0	14.0	

Specifications and Features

- Length: 2.5m.
- Material: Aluminum alloy with a smooth finish, easy to cut and install, available in various colors.
- Recessed Design: Suitable for both large and small spaces, providing a clean and organized appearance.
- Compatibility: The entire series is compatible with corner adapters.
- Caution: Avoid using acidic or strong alkaline cleaning agents. Residual water, cement, or cleaning chemicals may damage the surface. Please rinse and dry promptly.
- [Important Note]: Painted colors are not suitable for installation in wet or water-accumulating areas.
Painted colors: 12 Matte Black, 13 Sandy Black, 18 Ivory, 19 White

Color Options

Color Options	10 Coffee	12 Matte Black	13 Sandy Black
Model Number			
50202F	⊙	✓	⊙
35141F	⊙	✓	✓

Legend: ✓ Standard Product
 ✗ No Color Option Available
 ⊙ Custom Order Available



Internal Corner



External Corner



Connector Accessory (for 50202F)



End Cap

Construction Scenarios

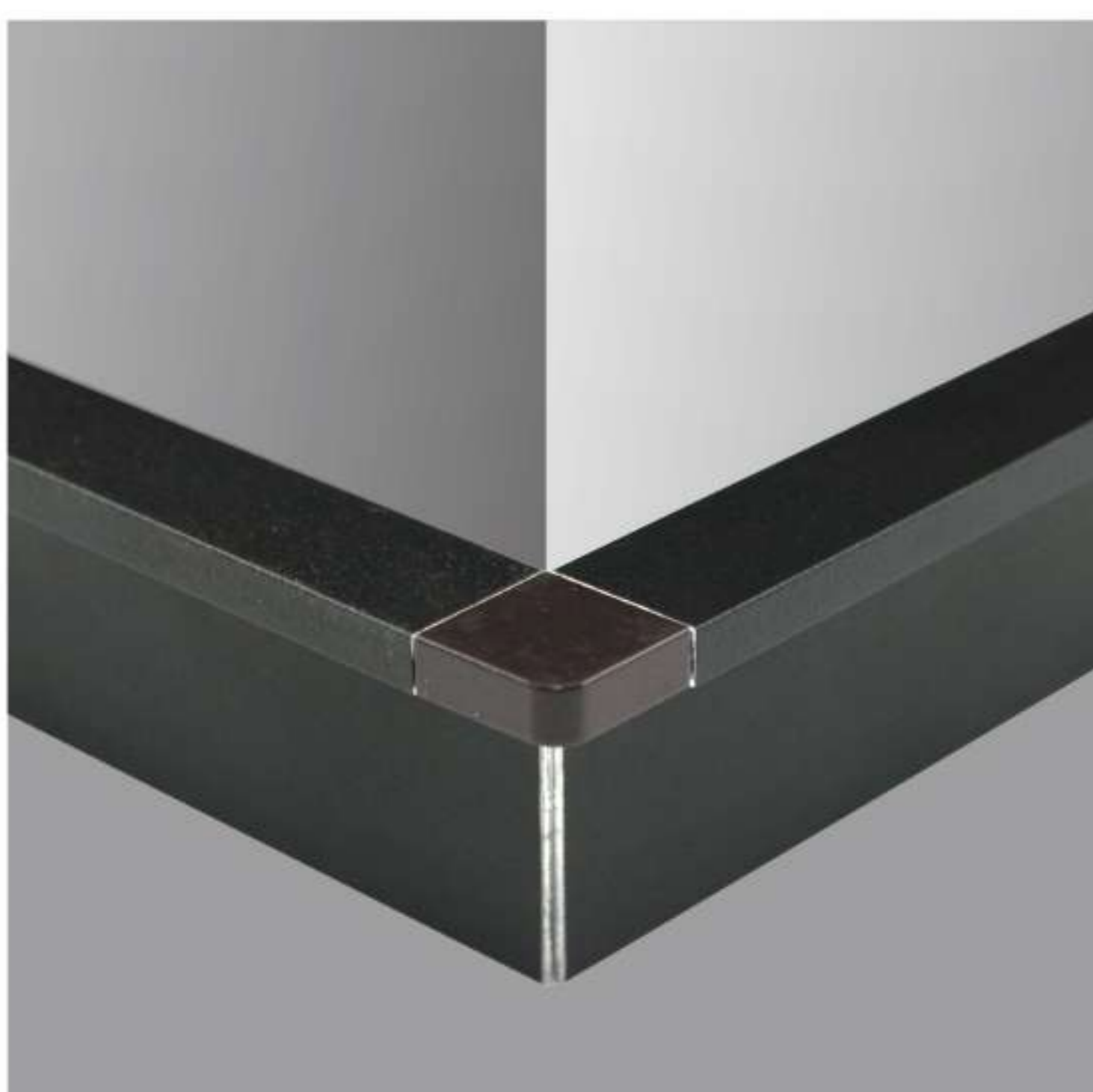

Outer Corner Assembly

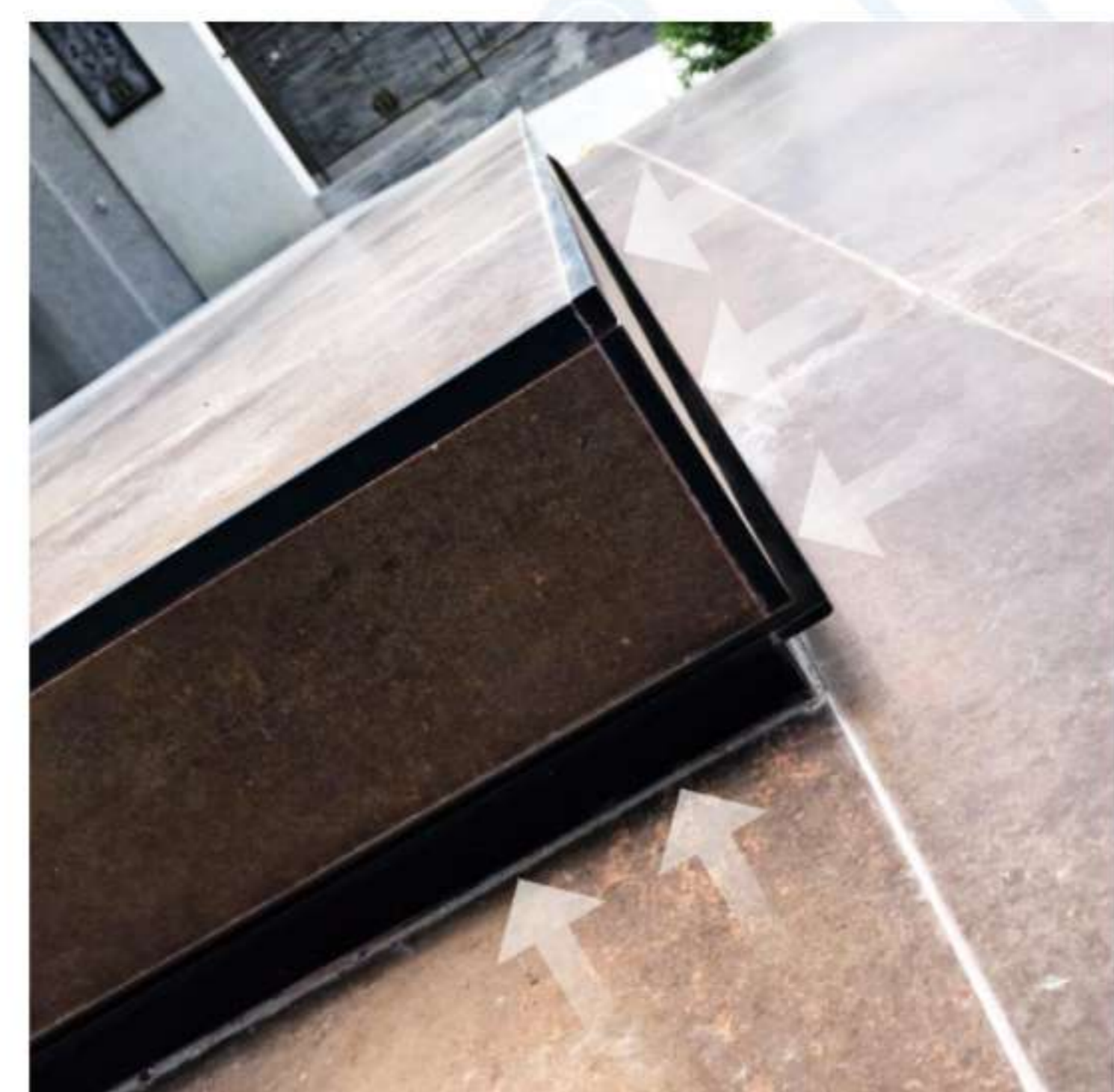
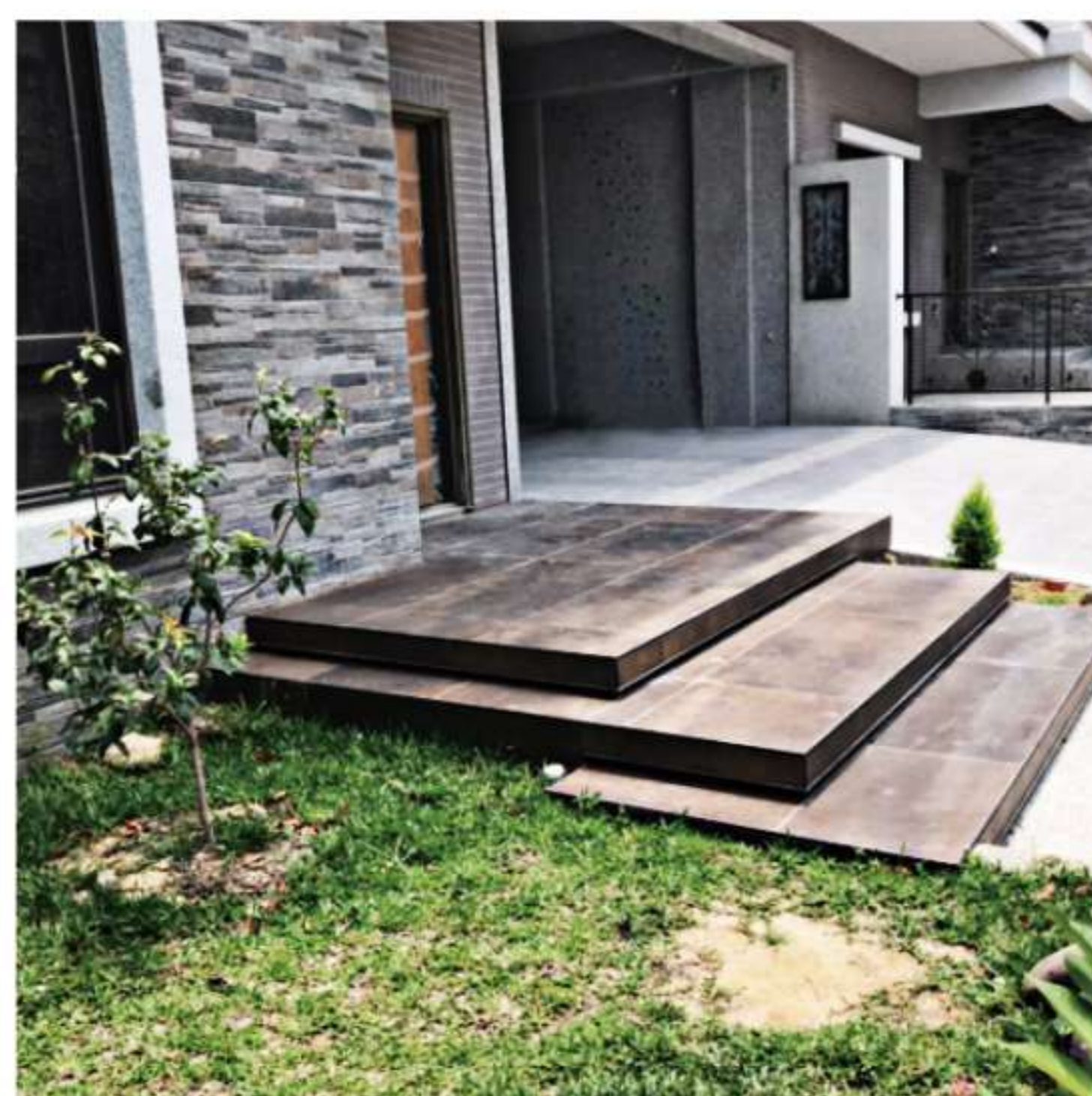



Aluminum Skirting Board Series



Model	Product Name	H (Height)	W (Width)	Unit: mm
00501F	Aluminum Alloy 50mm Skirting Board	50.0	8.0	
00801F	Aluminum Alloy 80mm Skirting Board	80.0	8.0	
01181F	Aluminum Alloy 118mm Skirting Board	118.0	10.0	

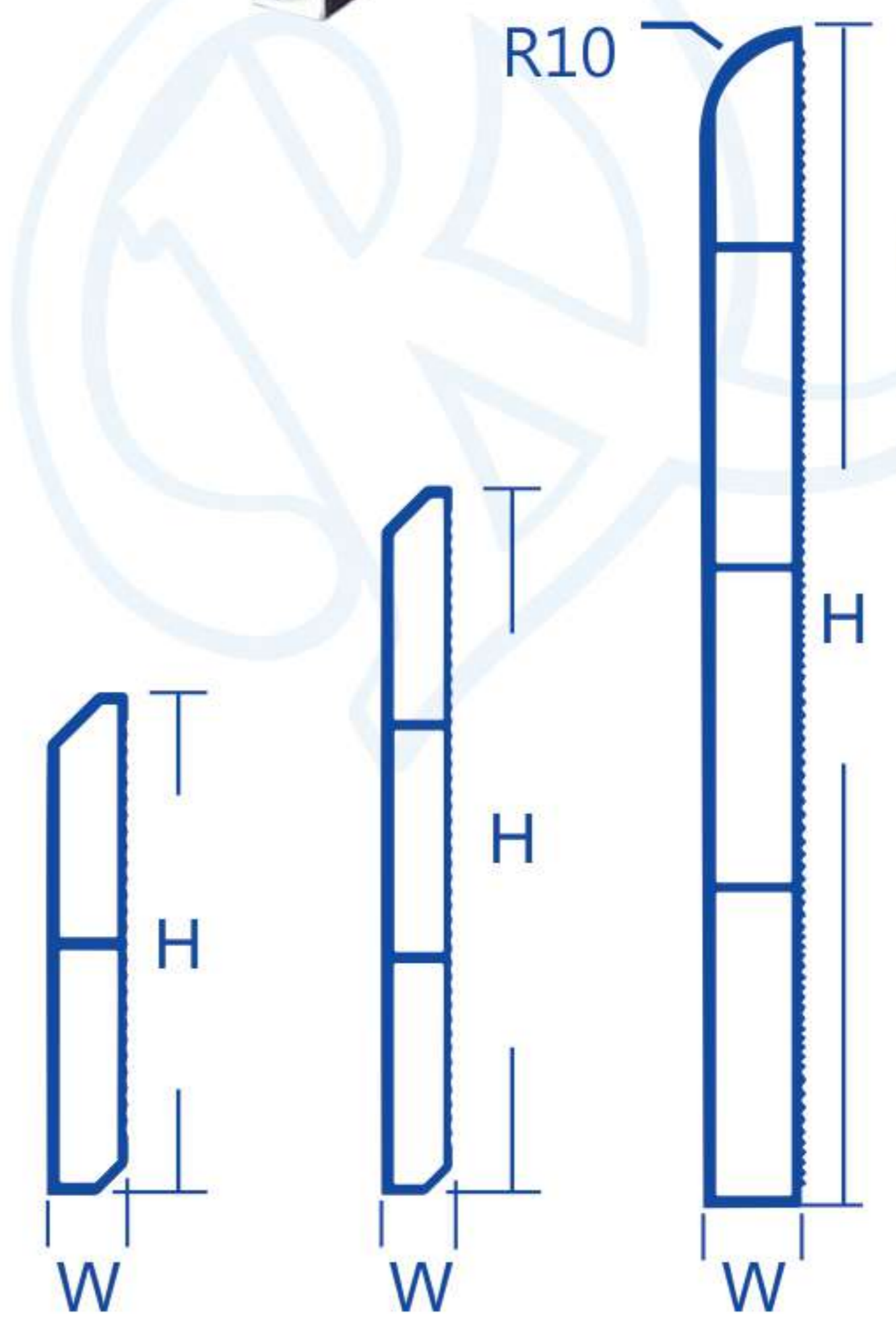

Specifications and Features

- Length options: 1.2m and 2.4m.
- Made from aluminum alloy, designed for easy cutting and installation with a variety of color options.
- Fully grooved on the back for enhanced adhesion and easier installation.
- Unique thickened design for impact resistance and durability.
- Compatible with both inner and outer corner configurations.
- Cleaning Reminder: Use a neutral detergent for cleaning. Avoid leaving cement or cleaning agents on the surface as they may cause corrosion. Rinse and dry promptly.
- [Caution]: Painted colors finishes should not be installed in damp or water-prone areas. Painted colors Options: 11 Silver Gray. 12 Matte Black . 91 Polished Black .92 Sandy Black.93 Polished Brown. 94 Sandy Brown

Color Options

Color Options	11 Silver Gray	91 Polished Black	92 Sandy Black	93 Polished Brown	94 Sandy Brown
Model Number					
00501F	✓	✓	✓	✗	✗
00801F	✓	✓	✓	✗	✗
01181F	✓	✓	✓	✓	✓

Legend: ✓ Standard Product ✗ No Color Option Available ⊙ Custom Order Available



Construction Scenarios

Outer Corner Assembly

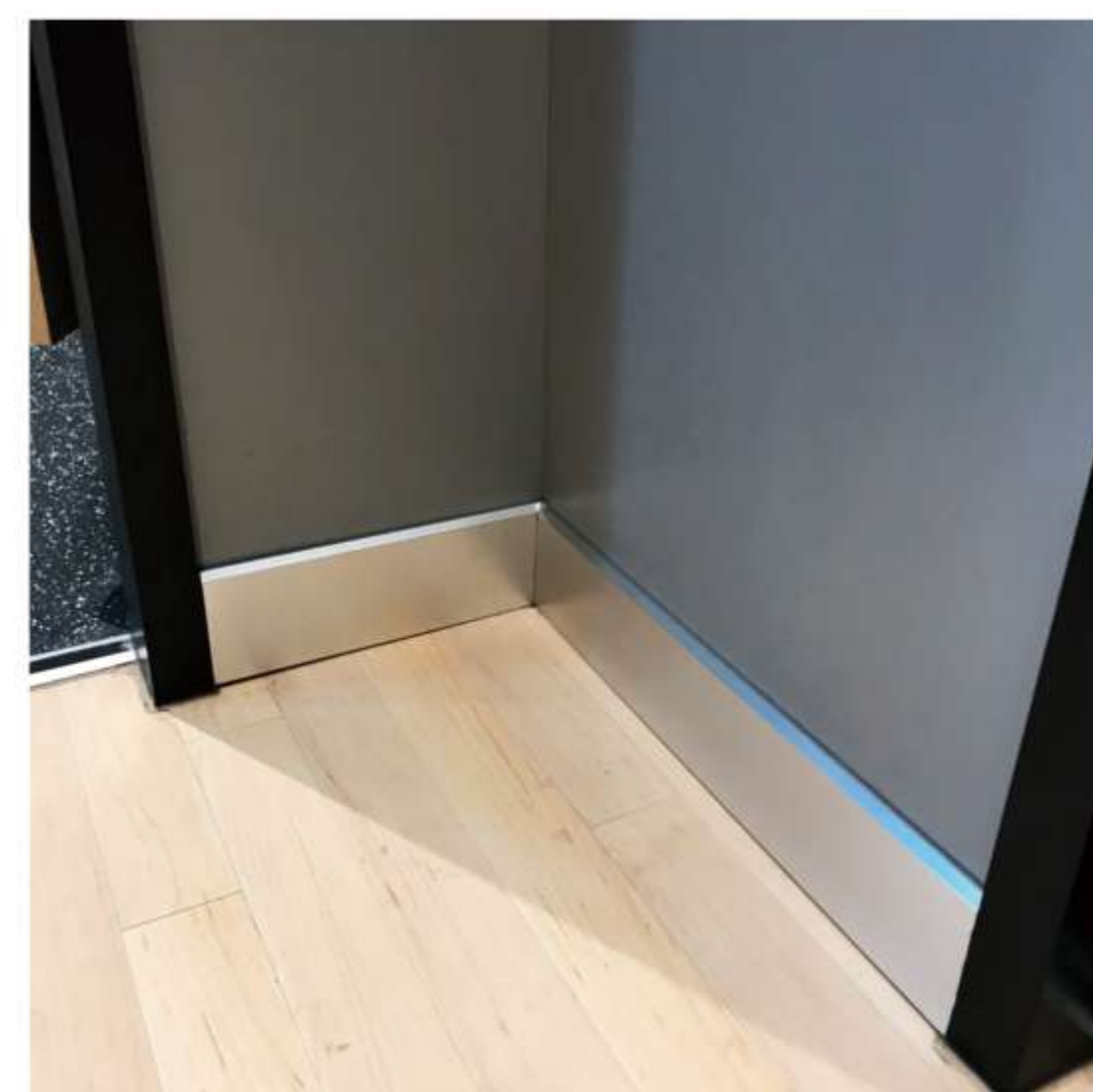



Pre-Installation Recessed Skirting Board Series



35151F

35151F

External Corner

Unit: mm

Model	Product Name	H (Height)	W (Width)
35151F	Pre-Installation 10mm Curved Recessed Skirting Board	15.0	35.0
40101F	Pre-Installation 10mm Recessed Skirting Board	10.0	40.0
40151F	Pre-Installation 15mm Recessed Skirting Board	15.0	40.0
50201F	Pre-Installation 20mm Recessed Skirting Board	20.0	50.0
50251F	Pre-Installation 25mm Recessed Skirting Board	25.0	50.0

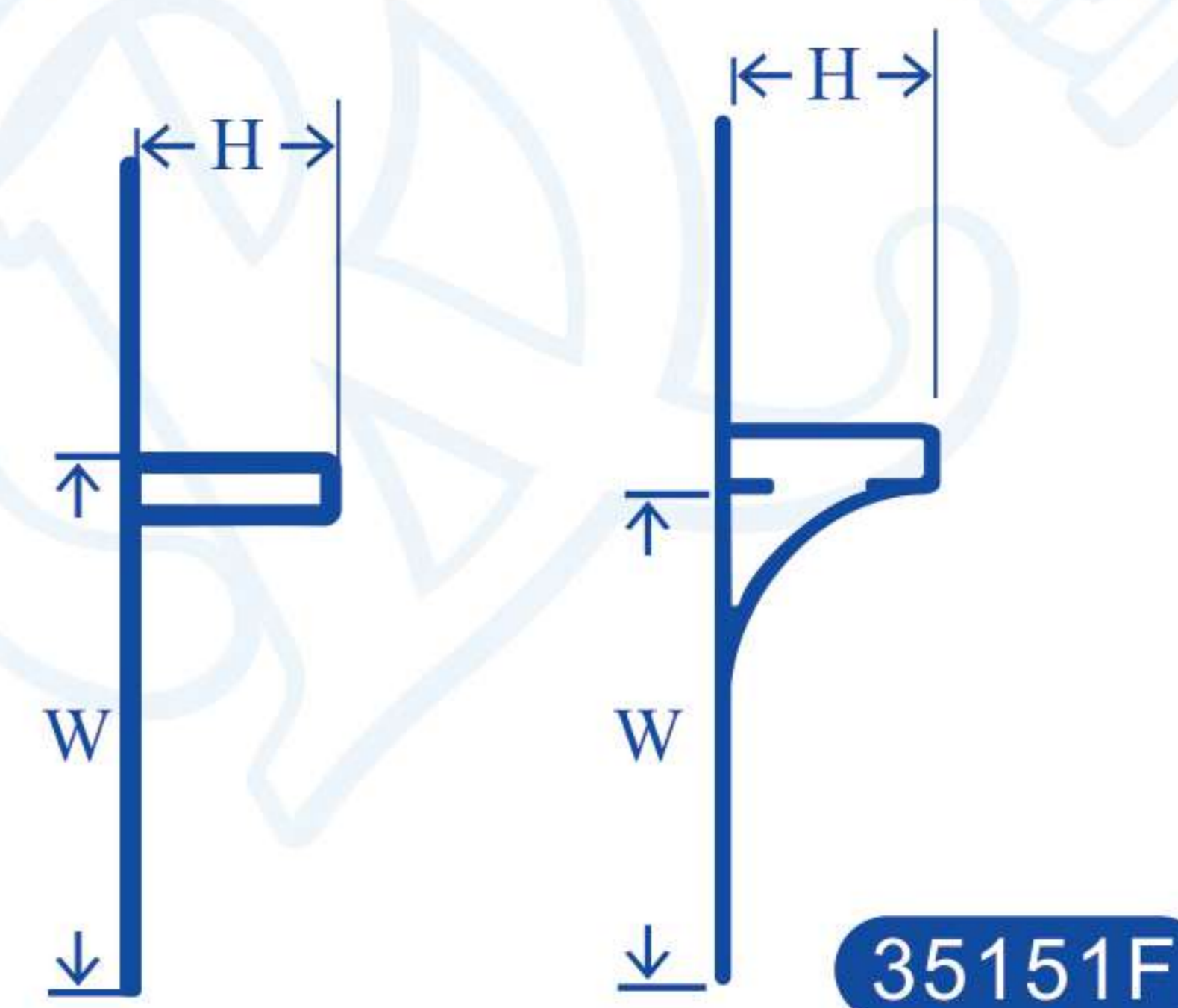

Specifications and Features

- Length: 2.5m.
- Unique safety corner design prevents sharp edge injuries.
- Aluminum alloy construction with a seamless design, offering ease of cutting and installation as well as diverse color options.
- Recessed skirting boards enhance the spatial perception and prevent corners from trapping dust or dirt.
- Compatible with a full range of corner and connection accessories.
- Recessed skirting boards are patented products (Patent Numbers: M549801, I690641, I646242).
- Cleaning Reminder: Use cleaning agents without high concentrations of acid to prevent corrosion. Avoid leaving cement or cleaning agents on the surface; rinse and dry promptly.
- [Caution]: Painted color products should not be installed in damp or water-prone environments. Painted Colors: 12 Matte Black. 13 Sandy Black. 18 Ivory. 19 White

Color Options

Model Number	Color Options	12 Matte Black
35151F		✓
40101F		✓
40151F		✓
50201F		✓
50251F		✓

Legend:

- ✓ Standard Product
- ✗ No Color Option Available
- ⊙ Custom Order Available

Construction Scenarios





Aluminum Alloy Stair Edge Protection Series

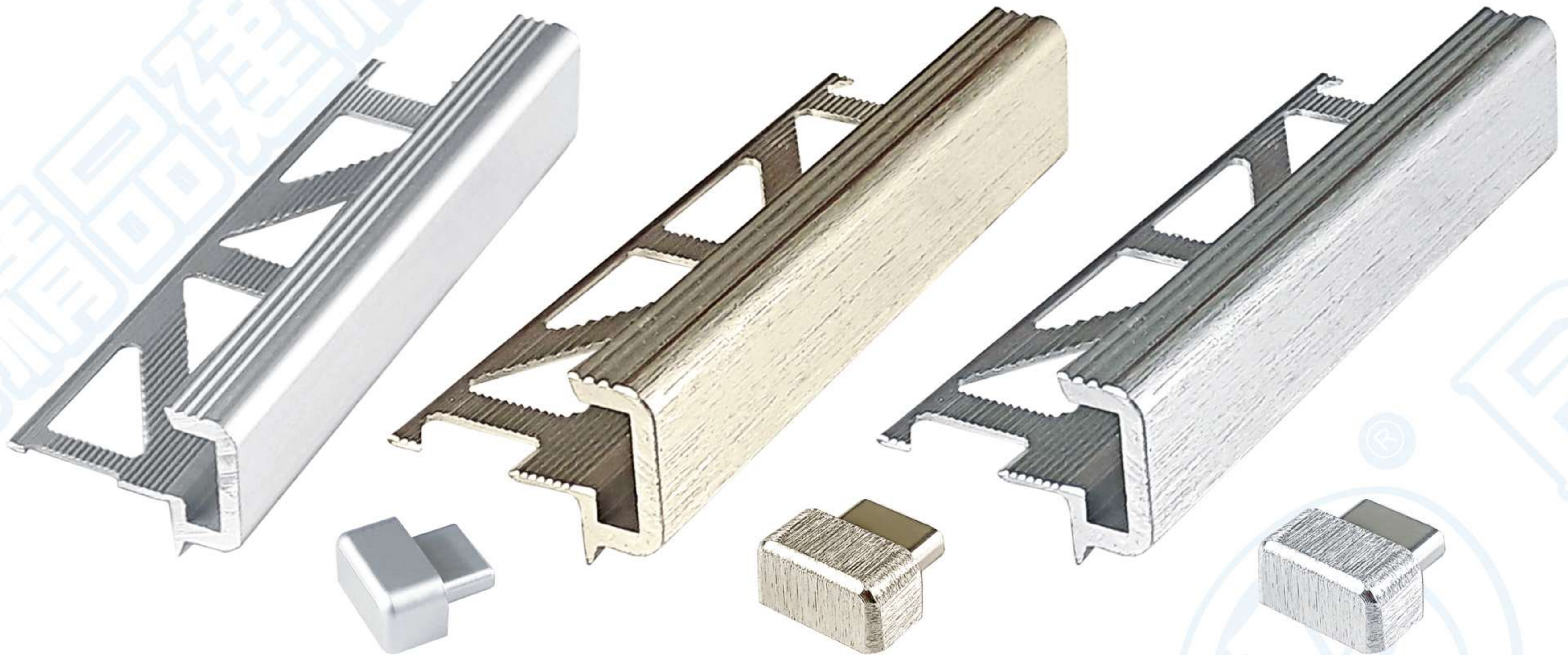

Model	Product Name	H (Height)	W (Width)	Unit: mm
11101G	Aluminum Alloy 11mm Stair Edge Protection	11.0	10.0	
13101G	Aluminum Alloy 13mm Stair Edge Protection	13.0	10.0	

Specifications and Features

- Length: 2.5m.
- Unique thickening design for enhanced surface impact resistance; corner safety cutting prevents injuries.
- Aluminum alloy construction, easy to cut and install, with various color options.
- In addition to anti-slip and stair edge protection, this product enhances overall aesthetics with a stone-like texture.
- Compatible with a full range of corner and end cap accessories.
- The stair edge protection strip features patented anti-slip technology (Patent Number: M498222), Counterfeiting will be prosecuted!
- Cleaning Reminder: Avoid using cleaning agents with high concentrations of acid. Cement residue or cleaning agents may corrode the surface; rinse and dry promptly.

Color Options

Color Options	16 Matte Silver	21 Silk Pattern Silver	22 Silk Pattern Champagne
Model Number			
11101G	✓	✓	✓
13101G	✓	✓	✓

Legend: ✓ Standard Product

Construction Scenarios

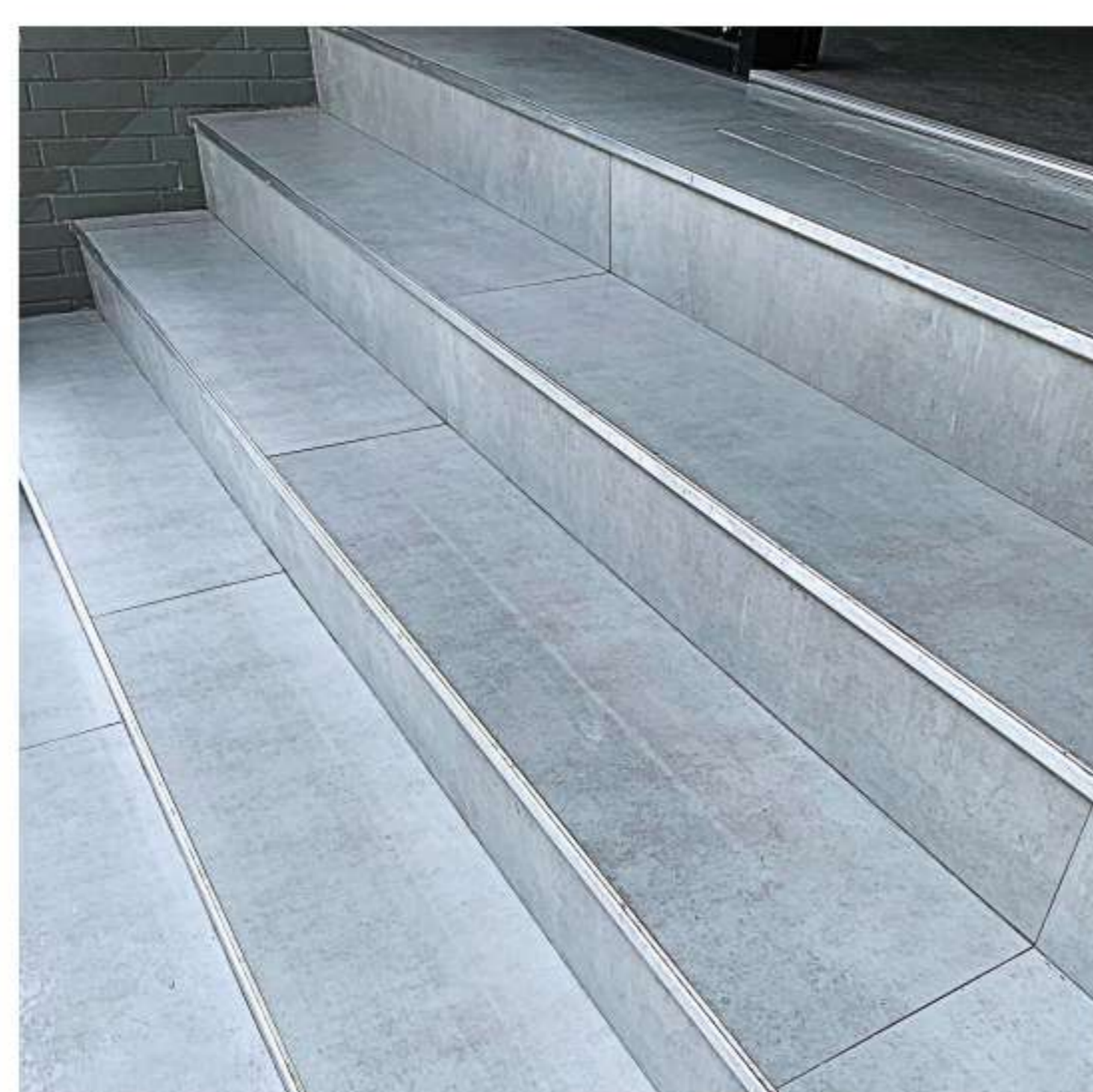



Aluminum Alloy Square Stair Edge Protection Trim Series



Model	Product Name	H (Height)	W (Width)	Unit: mm
11111G	Aluminum Alloy 11mm Square Stair Edge Trim	11.8	11.8	

Specifications and Features

- Length: 2.5m.
- Prevents slipping and protects tile edges and corners; enhances the overall quality, provides an interior-fitted finish, and is not prone to detachment.
- The entire series is compatible with corner fittings.
- Reminder: Avoid using excessively strong acidic or alkaline cleaning agents. Residual water, cement, or cleaning agents may damage the surface. Please clean and dry promptly.

Color Options

Color Options	Model Number	Color Name	Availability
	11111G	16 Matte Silver	✓

Legend: ✓ Standard Product ✗ No Color Option Available ⊕ Custom Order Available

Construction Scenarios

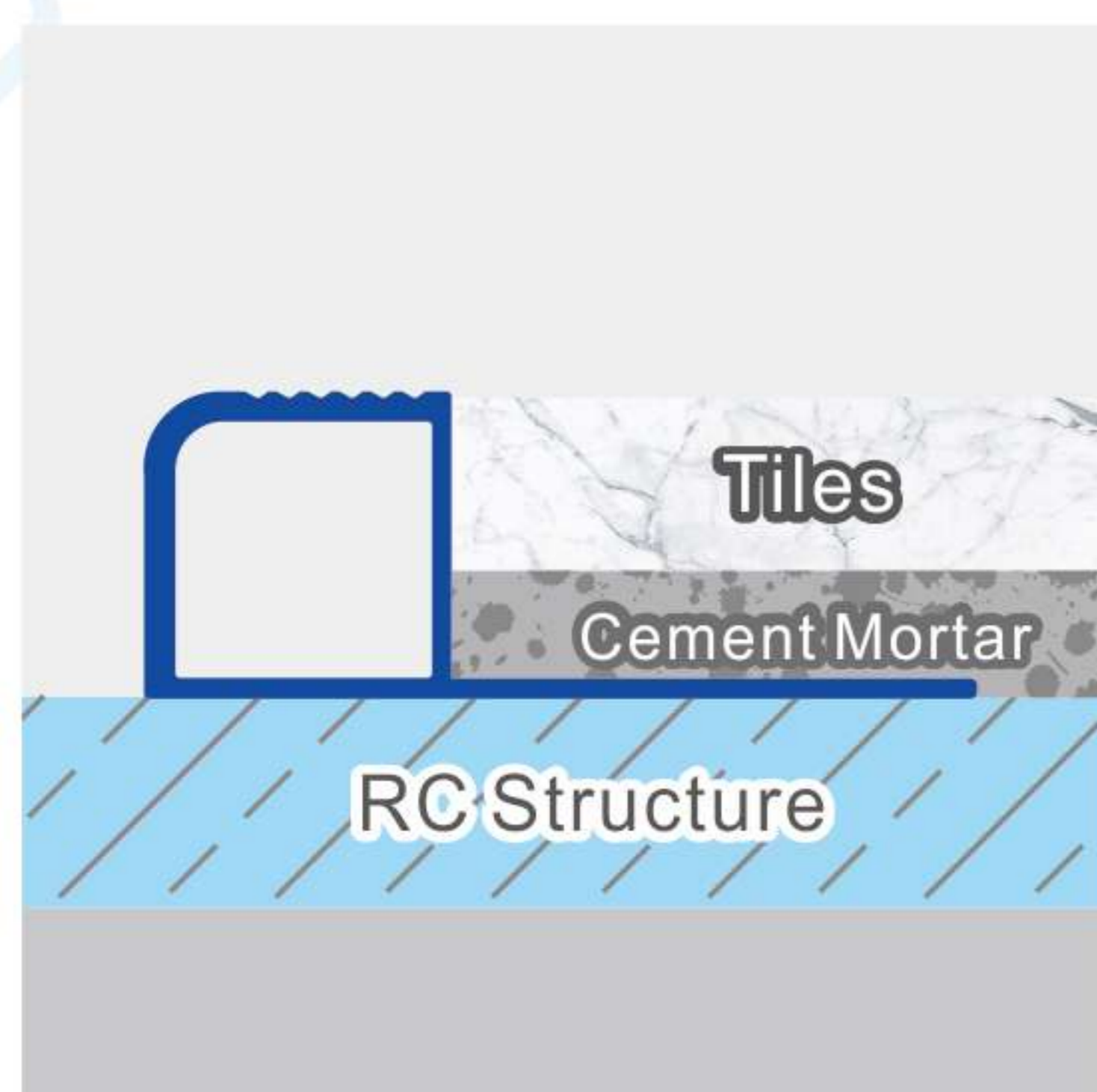



Aluminum Alloy Impact-Resistant Stair Edge Protection Series

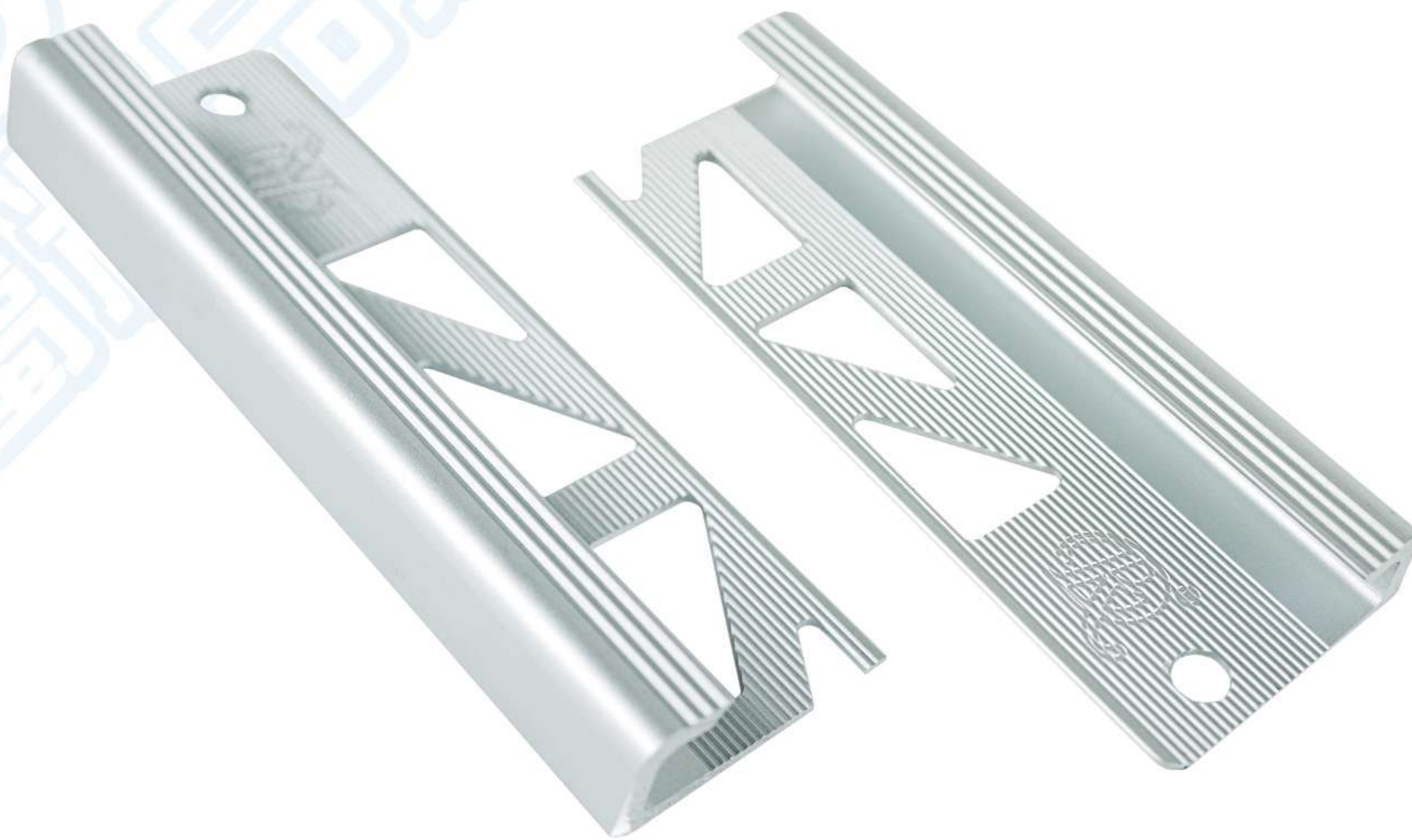

Unit: mm

Model	Product Name	H (Height)	W (Width)
11112G	Aluminum Alloy 11mm Impact-Resistant Stair Edge Protection	11.5	10

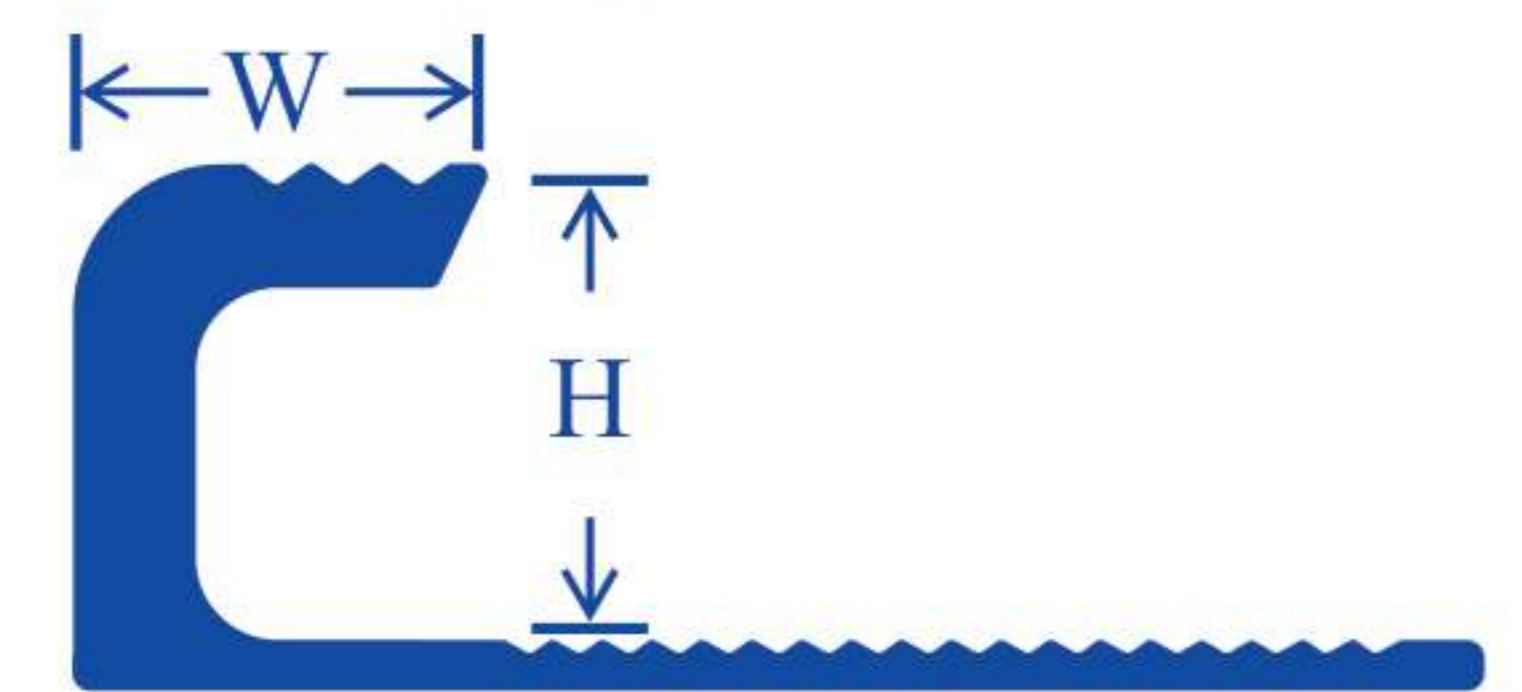

Specifications and Features

- Length: 2.5m.
- Anti-slip and protective design for tiled stair edges, enhancing overall aesthetics; internal installation method ensures it is not easily detached.
- Localized thickening design for enhanced surface impact resistance..
- Compatible with corner accessories across the series.
- Cleaning Reminder: Avoid using cleaning agents with high concentrations of acid. Cement residue or cleaning agents may corrode the surface; rinse and dry promptly.

Color Options

Color Code	Model Number	Availability
16 Matte Silver		
	11112G	✓

Legend: ✓ Standard Product ✗ No Color Option Available ⊙ Custom Order Available

Construction Scenarios

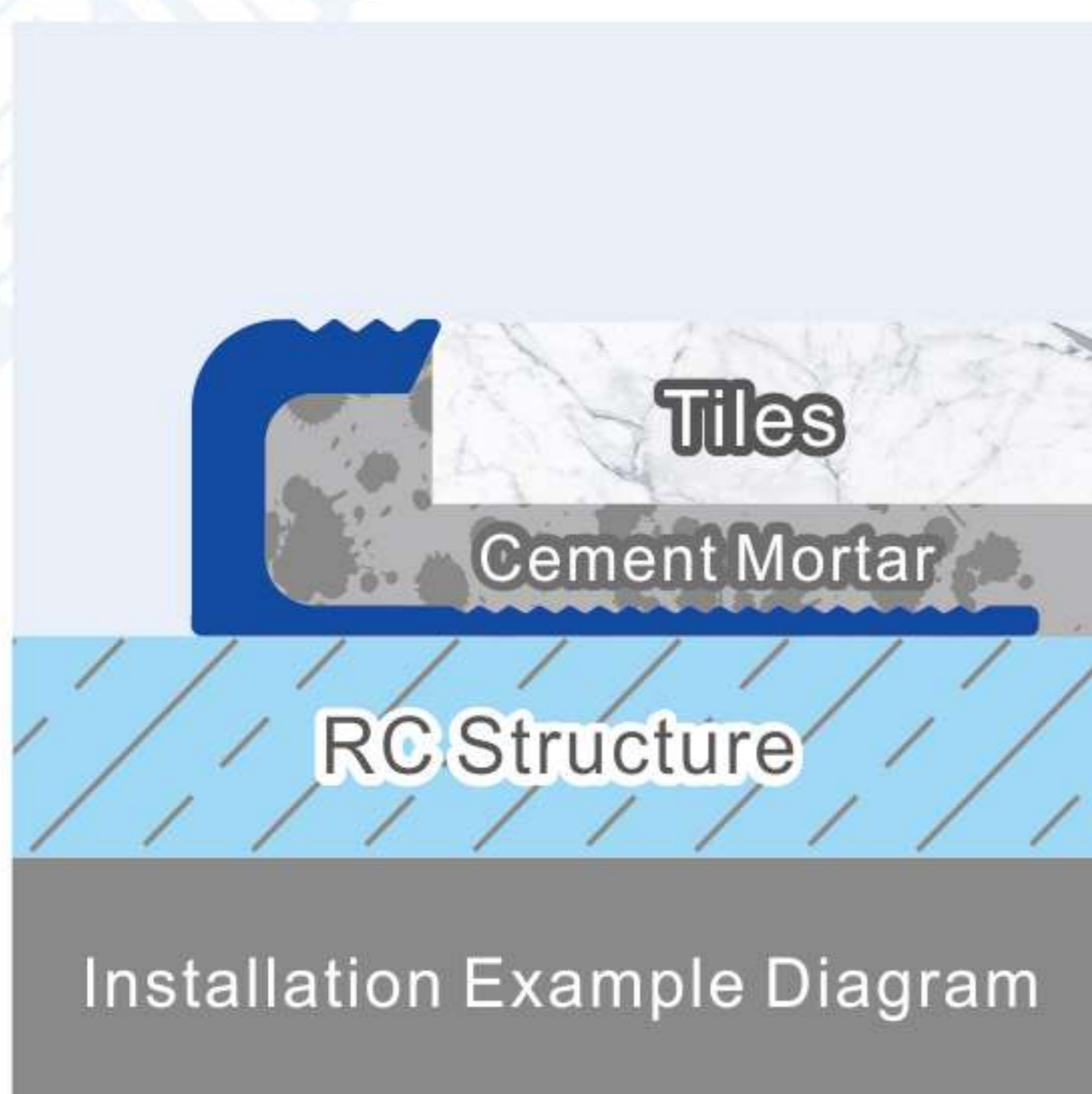



Aluminum Glass Groove Trim Series

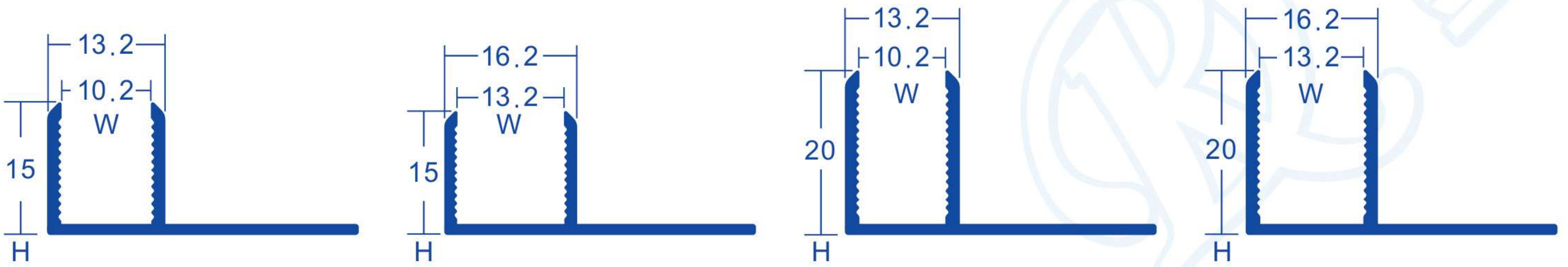
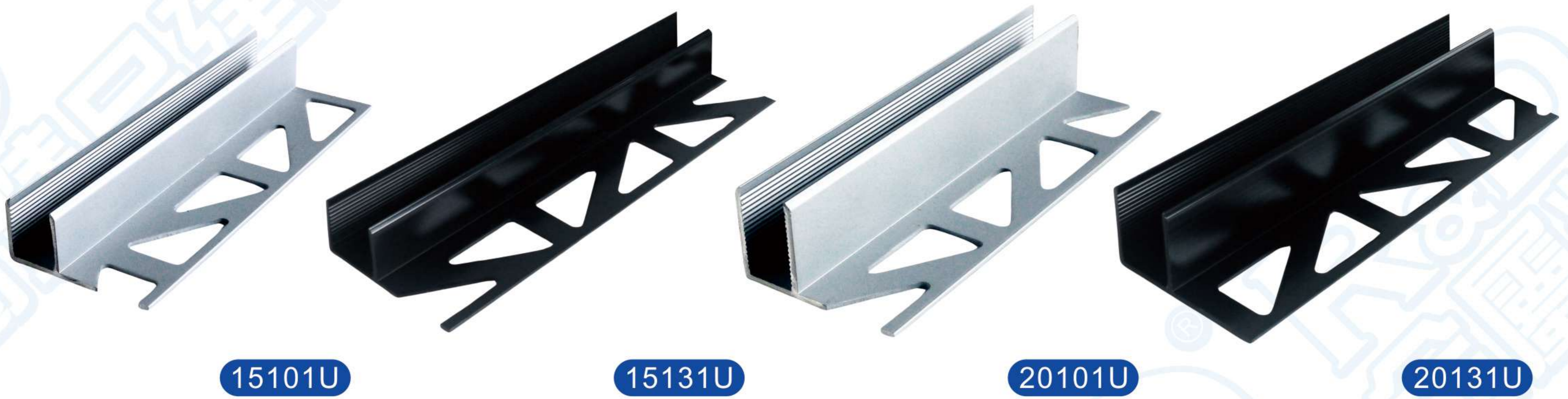

Unit: mm

Model	Product Name	H(mm)	W(mm)
15101U	Aluminum 15X10mm Glass Groove Trim Series	15	10.2
15131U	Aluminum 15X13mm Glass Groove Trim Series	15	13.2
20101U	Aluminum 20X10mm Glass Groove Trim Series	20	10.2
20131U	Aluminum 20X13mm Glass Groove Trim Series	20	13.2

Specifications and Features

- Standard length: 2.5 meters
- Enhanced structural design improves surface impact resistance; rounded corners prevent injuries
- Integrated aluminum profile, easy to cut and install, with multiple color options
- Easy installation, perfectly suited for glass construction applications
- Clean, streamlined lines maintain a neat and tidy bathroom appearance
- Exclusive design for improved stability and safety
- Note: Do not use cleaning agents containing salt, acid, or alkaline substances. Residual cement or detergent may corrode the surface—please rinse thoroughly with clean water

Color Options

Color Options	16 Mist Silver	27 Gloss Black
Model Number		
15101U	✓	✓
15131U	✓	✓
20101U	✓	✓
20131U	✓	✓

Legend: ✓ Standard Product
 ✗ No Color Option Available
 ⊙ Custom Order Available

Construction Scenarios





Aluminum Door Threshold Series

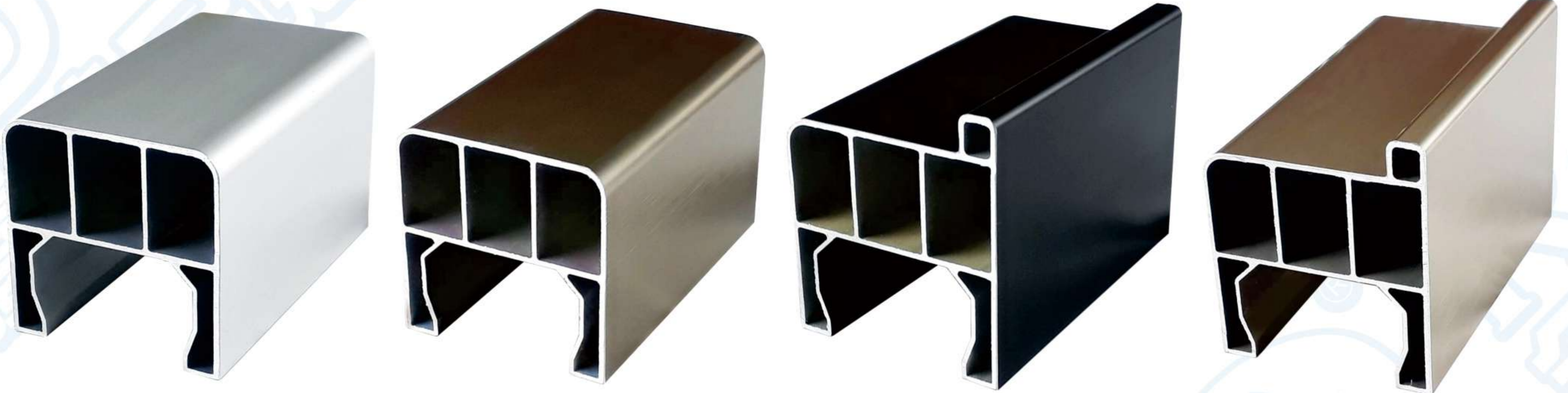

Unit: mm

Model	Product Name	H (Height)	W (Width)
66061D	Aluminum Alloy 6x6 U-Type Door Threshold	60.0	60.0
66062D	Aluminum Alloy 6x6 h-Type Door Threshold	60.0	60.0

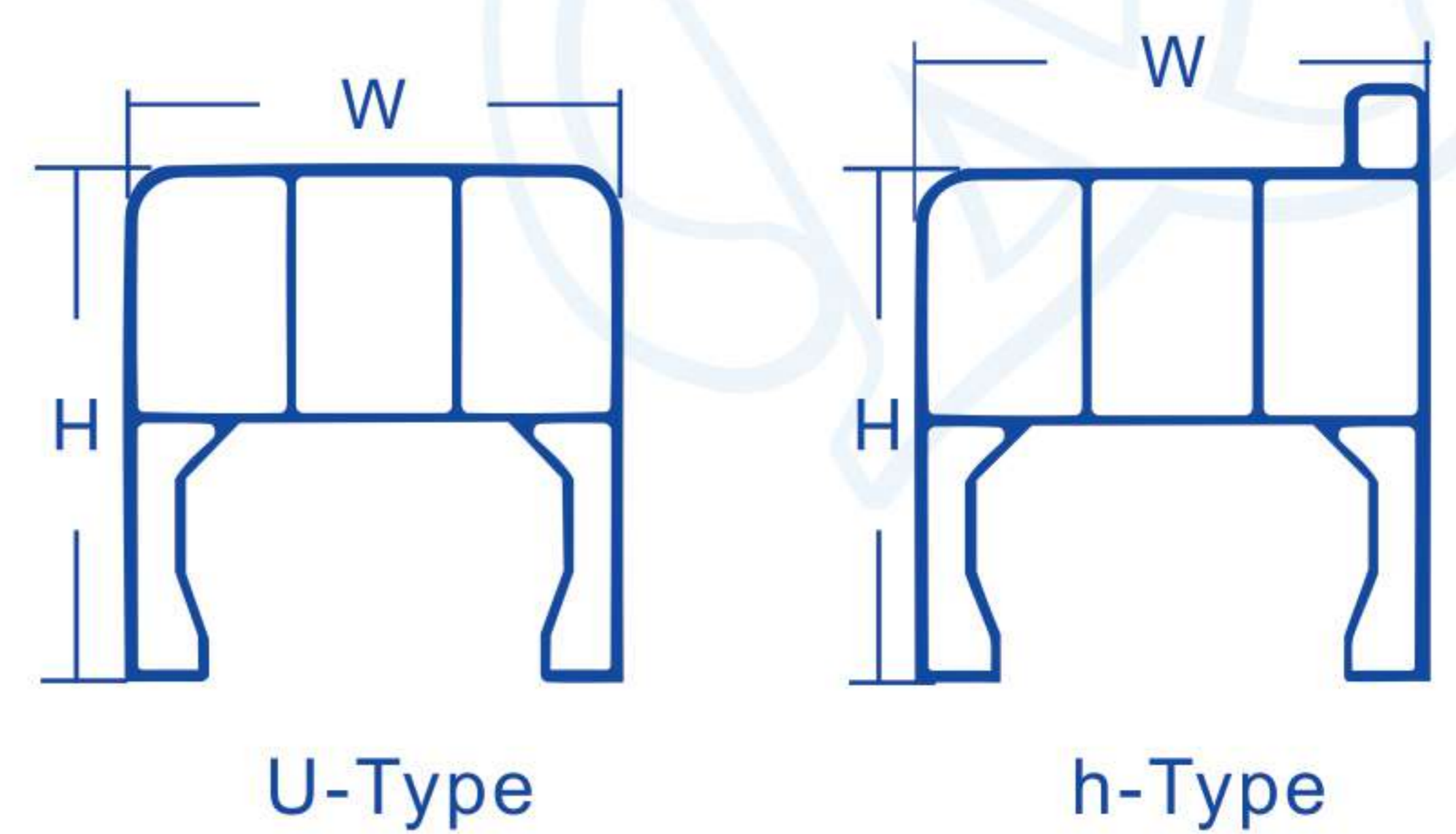

Specifications and Features

- Available in lengths of 3m or custom sizes.
- Made from aluminum alloy for a metallic finish.
- Easy to cut and install for convenient construction.
- High hardness, durable, and practical.
- Scratch-resistant, wear-resistant, and stylish.
- Cleaning Reminder: Do not use cleaning agents containing high concentrations of acidic substances. Cement residue or cleaning agents may corrode the surface. Rinse and dry promptly.

Color Options

Color Options	16 Matte Silver	22 Silk Pattern Champagne	25 Obsidian Black
Model Number			
66061D	✓	✓	✓
66062D	✓	✓	✓

Legend: ✓ Standard Product

Construction Scenarios





Stainless Steel Threshold Series



Unit: mm

Model	Product Name	H (Height)	W (Width)	T (Thickness)
60661C	Stainless Steel 60mm Equal-Height Threshold (with Inner Fold)	60	60	0.8
60662C	Stainless Steel 60mm Equal-Height Threshold	60	60	0.8

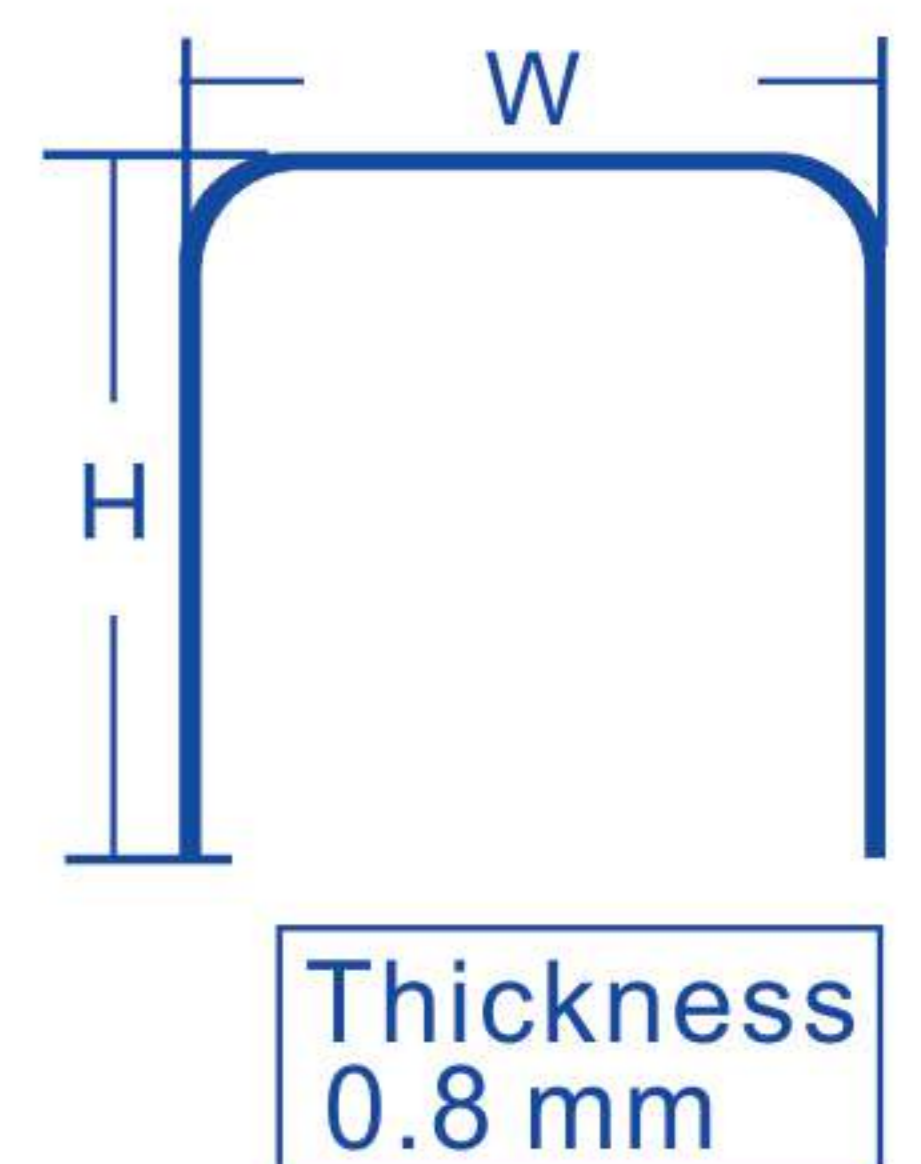
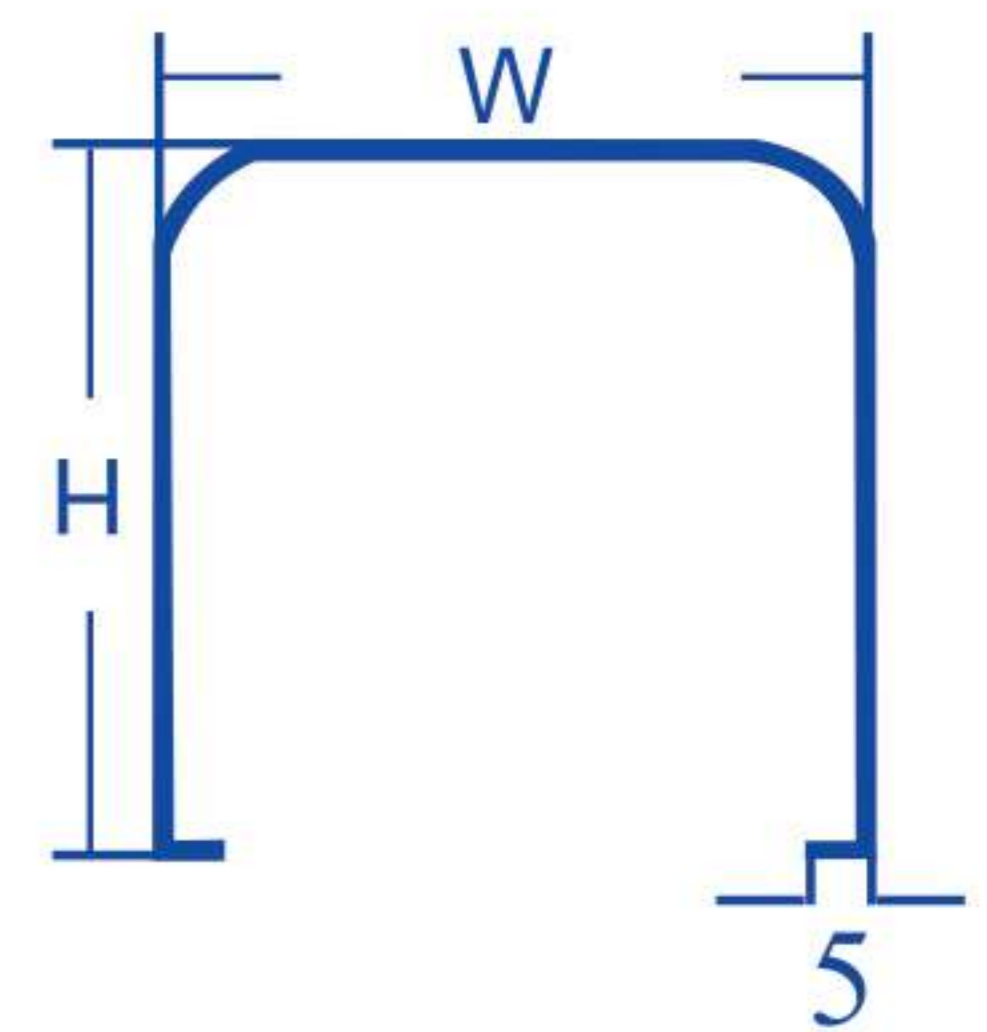

Specifications and Features

- Length: 2.5m. or customizable cutting length.
Made of SUS304 stainless steel, available in polished and matte finishes.
- Durable Stainless Steel Trim: High hardness, elegant appearance, and irreplaceable premium metallic texture.
- Unique Rounded Corner Design: Combines quality and aesthetic appeal.
- Customization Service: Custom width (W) and height (H) dimensions available upon request.
- Caution: Avoid using acidic or strong alkaline cleaning agents. Residual water, cement, or cleaning chemicals may damage the surface. Please rinse and dry promptly.

Color Options

Color Code	01 Polished Surface	02 Matte Surface
Model Number		
60661C	⊙	✓
60662C	⊙	✓

Legend: ✓ Standard Product ✗ No Color Option Available ⊙ Custom Order Available



Stainless Steel High-Low Threshold Series



40251T



40201T

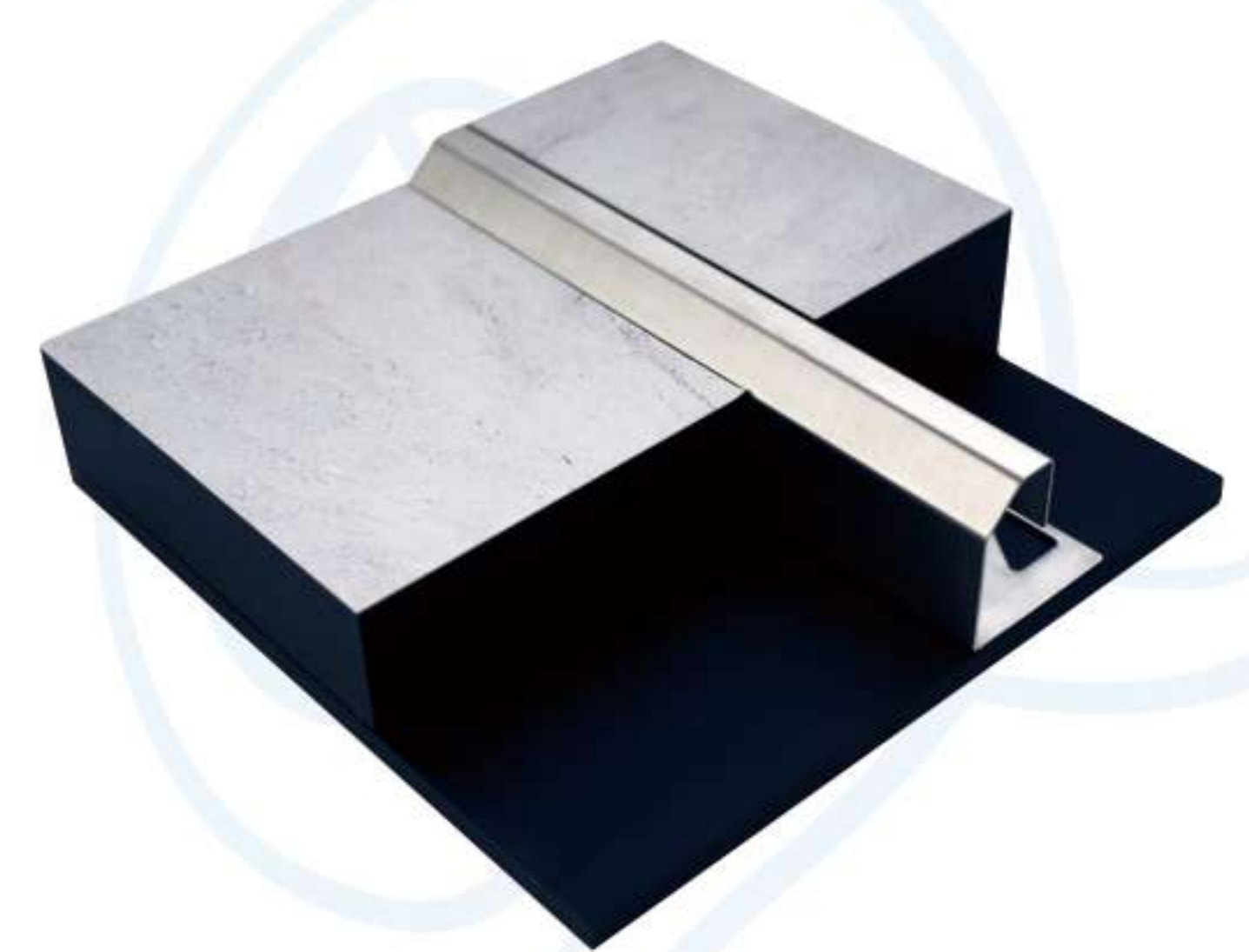
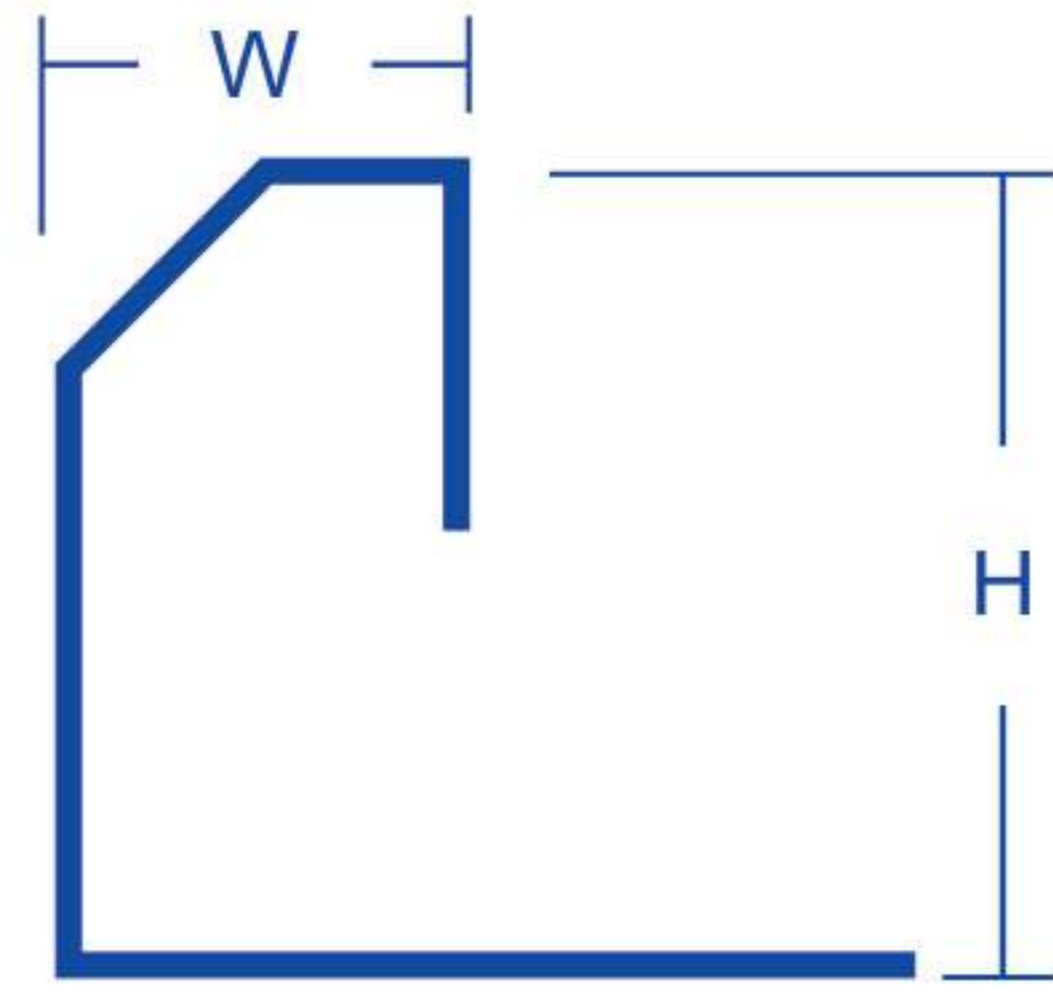
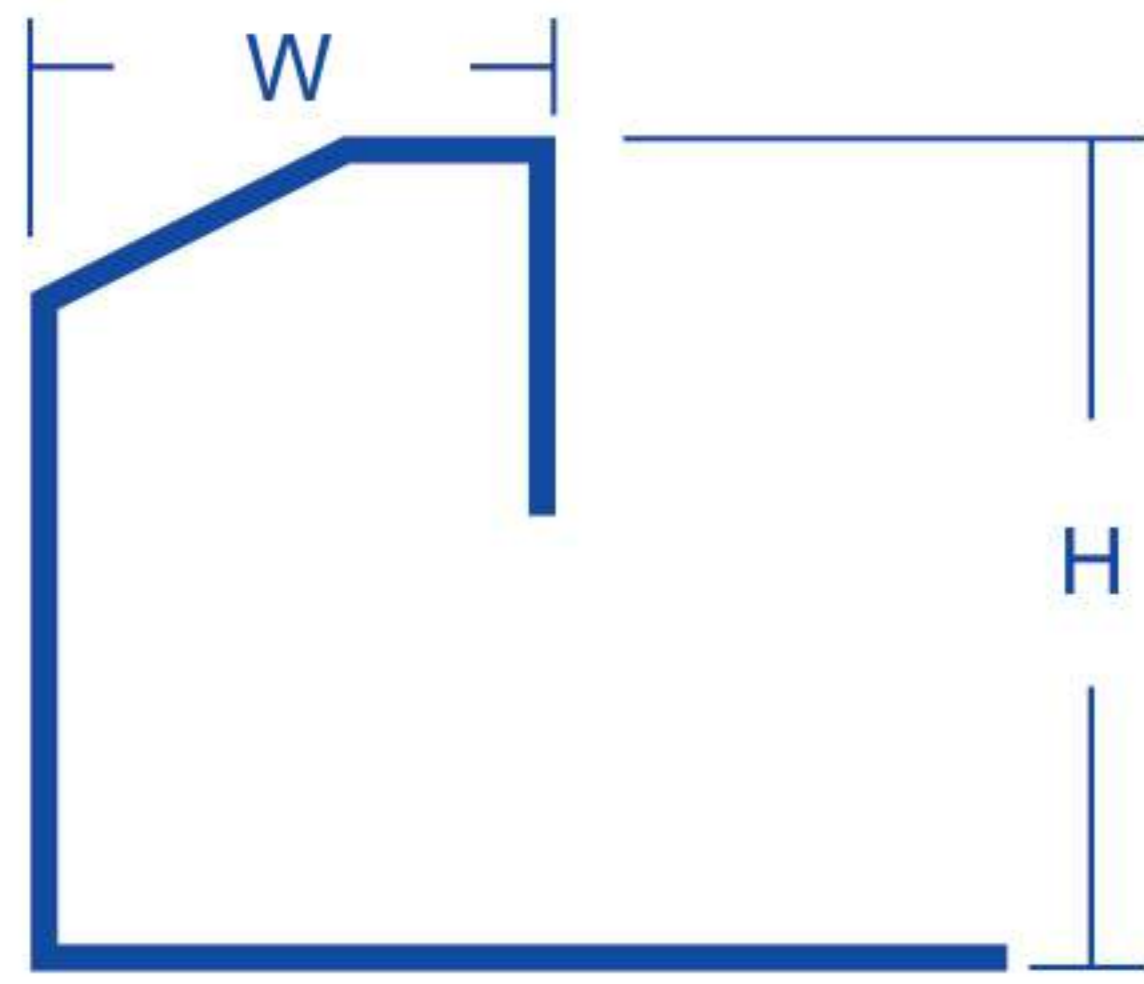

Model	Product Name	H (Height)	W (Width)
40251T	Stainless Steel 25mm Barrier-Free Height Difference	40.0	25.0
40201T	Stainless Steel 20mm Height Difference	40.0	20.0

Unit: mm

Specifications and Features

- Suitable for frameless sliding doors, artificial stone door thresholds, offering aesthetic appeal and water-blocking functionality. Includes sloped edges for wheelchair access. Complies with 40251T accessibility standards, made of 304 stainless steel for durability and easy cleaning.
- The Stainless Steel High-Low Threshold Series is a patented product (Patent Number: M584365).Reminder: Avoid using cleaning agents containing strong acids or alkalis.
- Residual cement or cleaning agents may damage the surface, so clean and dry promptly.

Color Options

Color Code	01 Polished Surface	02 Matte Surface
Model Number		
40251T	⊙	✓
40201T	⊙	✓

Legend: ✓ Standard Product ✗ No Color Option Available ⊙ Custom Order Available

Construction Scenarios

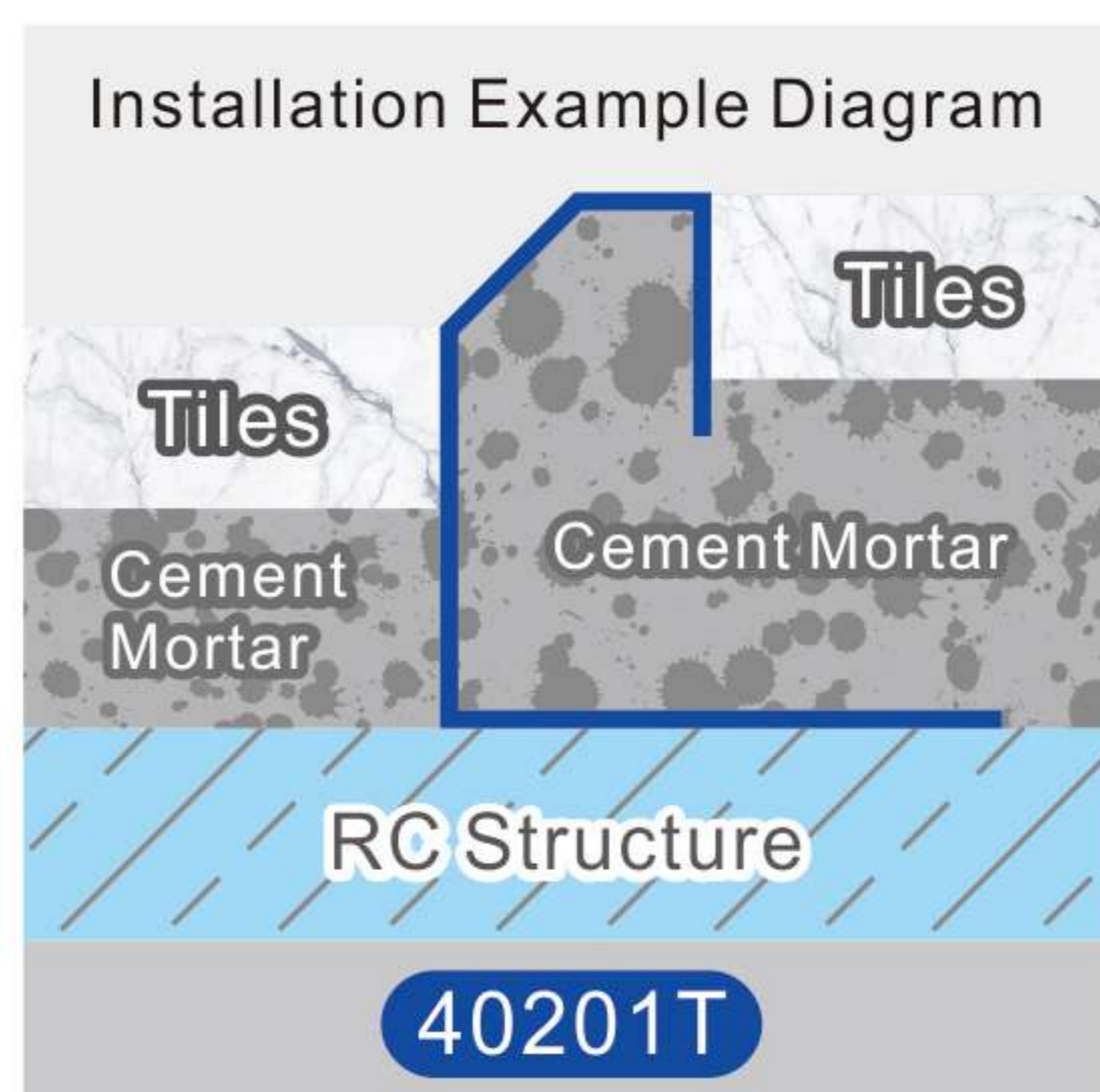
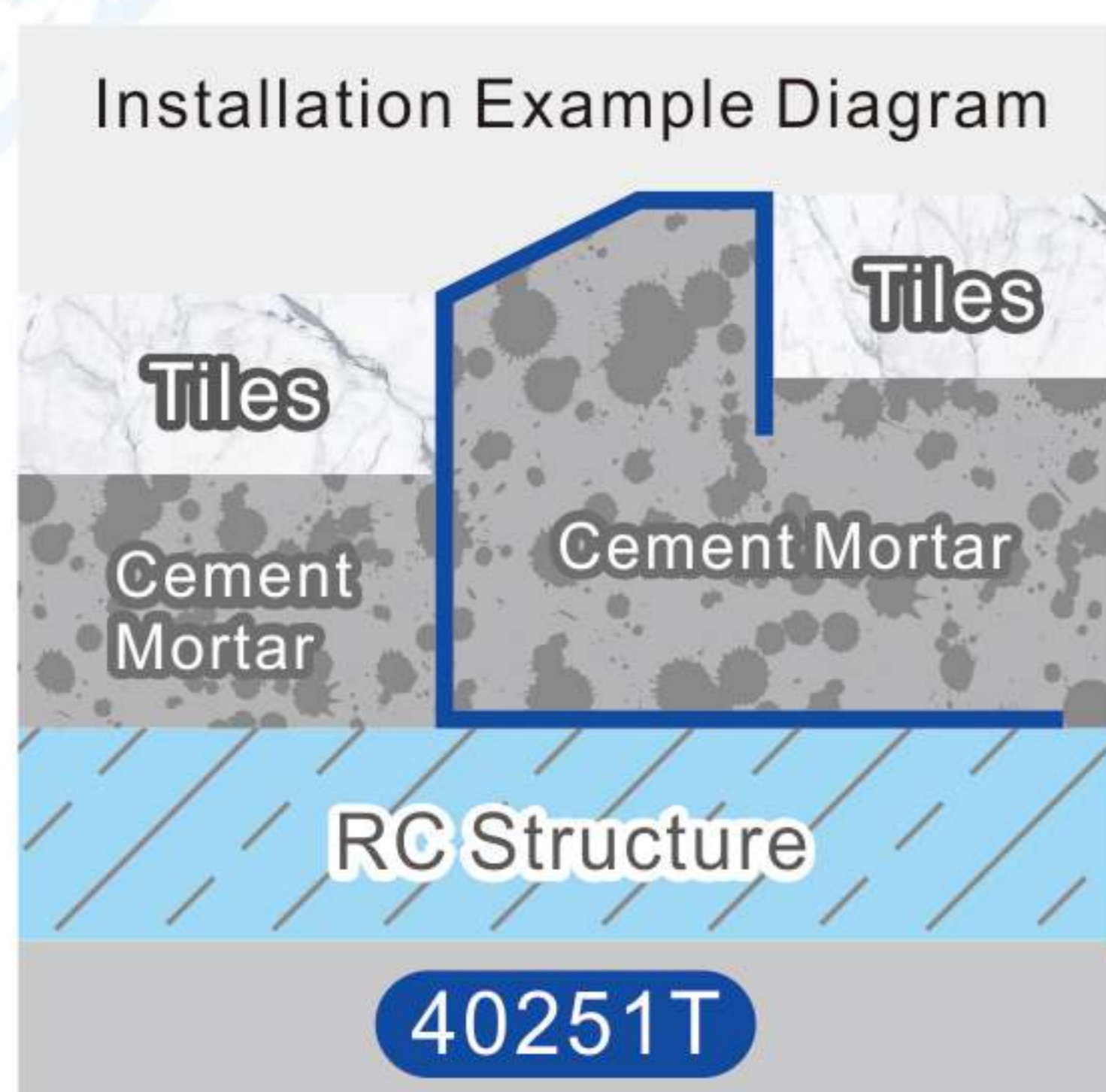



Stainless Steel 6mm Narrow Edge High-low Threshold





Model	Product Name	H (Height)	W (Width)	T (Thickness)	Unit: mm
40061L	Stainless Steel 6mm Narrow Edge High-Low Threshold	40	6.5	0.8	



Specifications and Features

- Length: 2.5m ; made of SUS304 stainless steel with a choice of glossy or matte finishes.
- The stainless steel trim is sturdy and elegant, exuding a refined metallic texture that is irreplaceable.
- Designed with narrow-edged stainless steel trim to separate different areas, fulfilling the needs of varying height differences.
- Unique rounded edge design, offering both quality and aesthetic appeal.
- Warning: Avoid using cleaning agents containing high concentrations of acid or alkali. Residual water or dirt may corrode the surface. Please clean and dry promptly.

Color Options

Color Code	01 Polished Surface	02 Matte Surface
Model Number		
40061L	⊙	✓

Legend: ✓ Standard Product ✗ No Color Option Available ⊙ Custom Order Available

Construction Scenarios

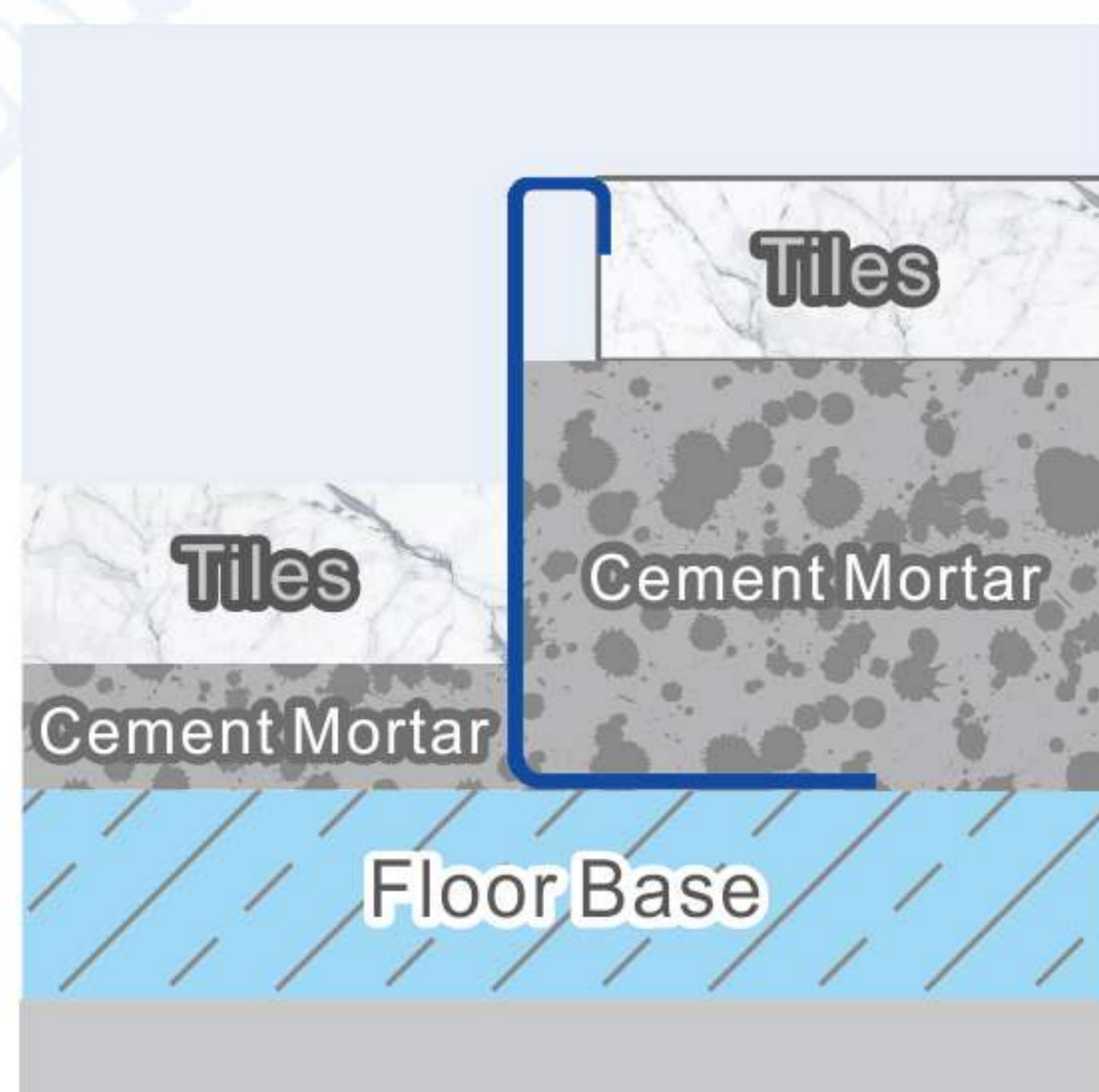



Stainless Steel U-Type Trim Series



Model	Product Name	H (Height)	W (Width)	T (Thickness)
09081C	Stainless Steel 9mm U-Shaped Trim	8.0	9.0	0.5
12111C	Stainless Steel 12mm U-Shaped Trim	11.0	12.0	0.5
10081C	Stainless Steel 10mm U-Shaped Trim	8.0	10.0	0.8
12081C	Stainless Steel 12mm U-Shaped Trim	8.0	12.0	0.8
15081C	Stainless Steel 15mm U-Shaped Trim	8.0	15.0	0.8
20081C	Stainless Steel 20mm U-Shaped Trim	8.0	20.0	0.8
25081C	Stainless Steel 25mm U-Shaped Trim	8.0	25.0	0.8

Unit: mm

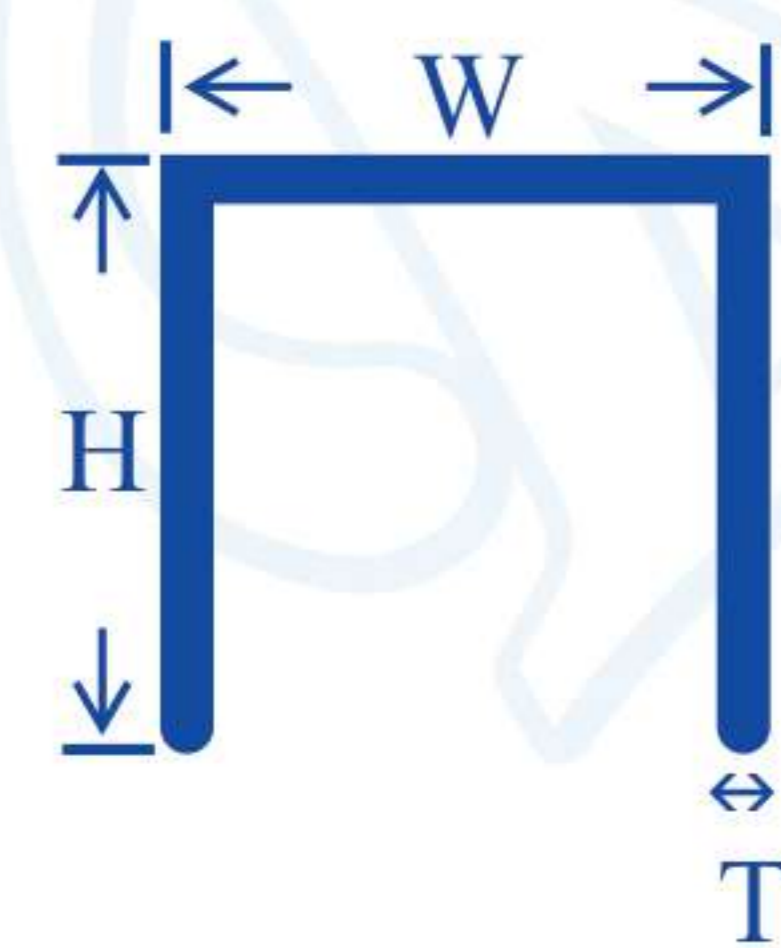

Specifications and Features

- Length: 2.5m ; Material: SUS304 stainless steel, available in polished and matte finishes.
- Stainless steel trim is robust and durable, offering a modern aesthetic. The cold metallic texture is irreplaceable.
- Exclusive small corner design, combining functionality and aesthetics.
- All series are compatible with corner pieces.
- Custom sizes available upon request.
- Warm Reminder: Avoid using cleaning agents containing strong acids or alkalis. Residual cement or cleaning agents may corrode the surface; clean and dry promptly.

Color Options

Color Code	01 Polished Surface	02 Matte Surface
Model Number		
09081C	✓	⊙
12111C	✓	⊙
10081C	✓	⊙
12081C	✓	⊙
15081C	✓	⊙
20081C	✓	⊙
25081C	✓	⊙

Legend: ✓ Standard Product
 ✗ No Color Option Available
 ⊙ Custom Order Available

Construction Scenarios



Outer Corner Assembly

Inner Corner Assembly





Stainless Steel Square Edge Trim Series



Model	Product Name	H (Height)	W (Width)	T (Thickness)
10081L	Stainless Steel 10.7mm Square Edge Trim	10.7	8.0	0.8
12081L	Stainless Steel 12.5mm Square Edge Trim	12.7	8.0	0.8
15081L	Stainless Steel 15mm Square Edge Trim	15.2	8.0	0.8

Unit: mm



Thickness
0.8 mm

Specifications and Features

- Length: 2.5m ; made of SUS304 stainless steel, available in bright and matte finishes.
- Durable and Elegant: Stainless steel edge trims are sturdy, aesthetically pleasing, and exude a premium metallic quality.
- Applications: Can be used on frames for doors or windows, Suitable for dividing lines on wall waistlines or floors.
- Exclusive Design: Features a compact and rounded design, combining functionality and aesthetic elegance.
- Accessories: Complete series available with corner connectors.
- Custom Sizes: Other dimensions available upon request.
- Cleaning Reminder: Avoid using acidic or corrosive cleaning agents. Residue such as mud or cleaning solutions may damage the surface. Clean and dry promptly.

Color Options

Color Code	01 Polished Surface	02 Matte Surface
Model Number		
10081L	✓	✓
12081L	✓	✓
15081L	✓	⊙

Legend: ✓ Standard Product ✗ No Color Option Available ⊙ Custom Order Available



Corner Piece
(Universal for Inner and Outer)

Construction Scenarios



Outer Corner Assembly



Inner Corner Assembly





Stainless Steel Triangular Edge Trim Series

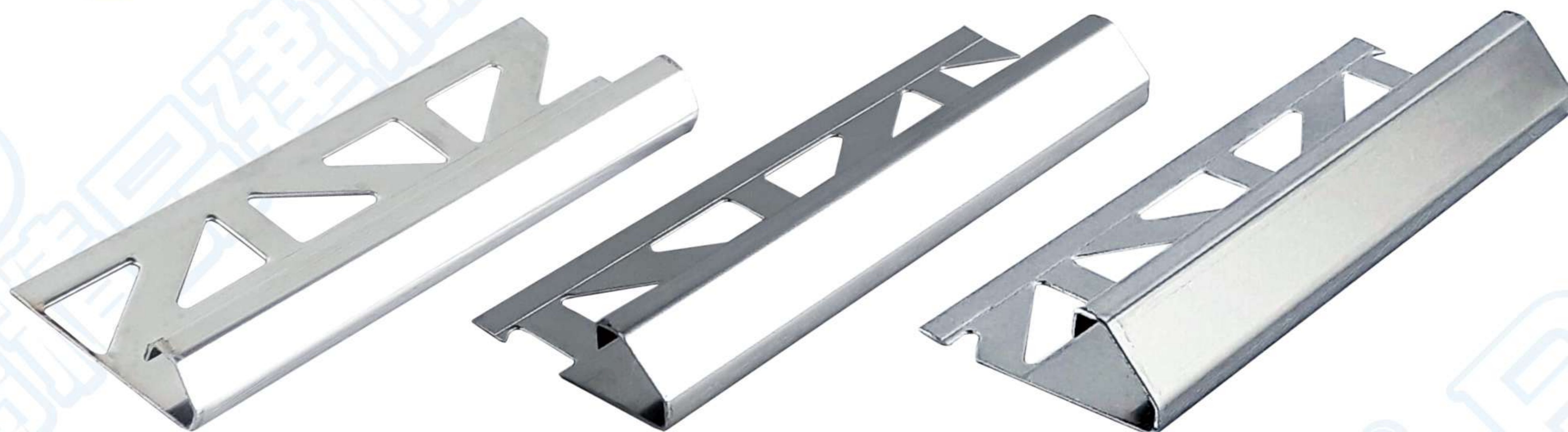

Model	Product Name	H (Height)	W (Width)	T (Thickness)
08001T	Stainless Steel 8.8mm Triangular Edge Trim	8.8	9.3	0.5
11002T	Stainless Steel 11mm Triangular Edge Trim	11.0	11.5	0.5
12002T	Stainless Steel 12.5mm Triangular Edge Trim	12.5	13.0	0.5

Unit: mm

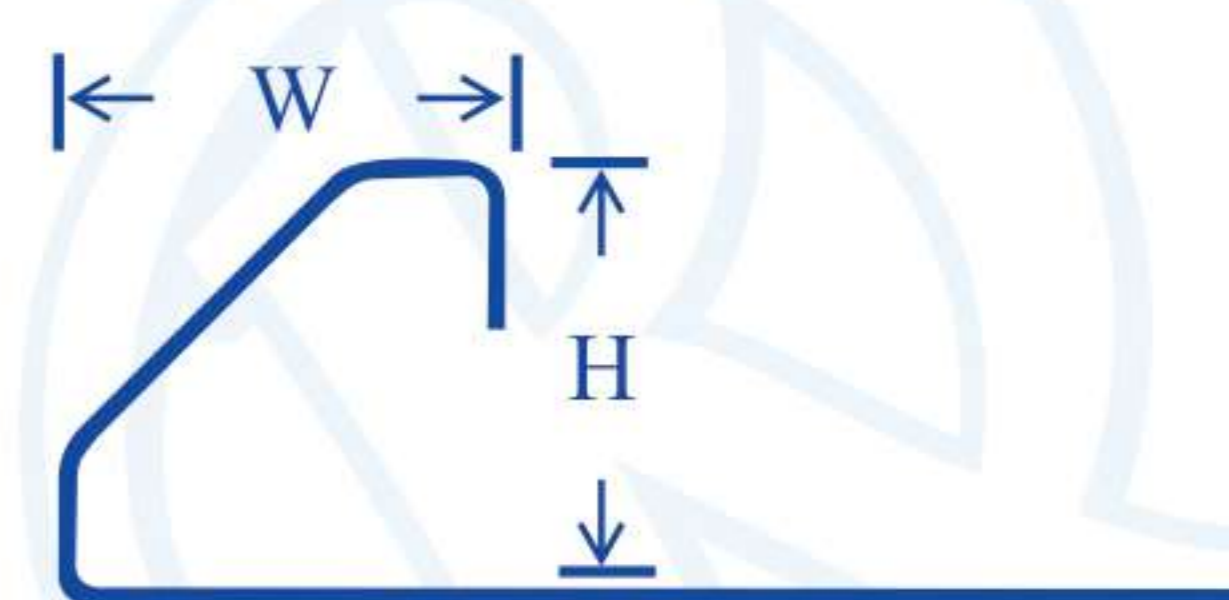

Specifications and Features

- Length: 2.5m ; made from SUS304 stainless steel, available in bright and matte finishes.
- Durability and Aesthetics: Stainless steel edge trims are sturdy, aesthetically pleasing, and offer an unmatched metallic texture.
- Applications: Triangular edge trims can be used for column edges, beams, window frames, and door frames. The 45-degree beveled edge adds a touch of modern sophistication.
- Unique Design: Features a compact and rounded corner design, combining quality with aesthetic elegance.
- Accessories: Full range of external corners and three-way connectors available.
- Exclusive Product: Stainless steel triangular edge trims are patented products (Patent Number: M498226); counterfeits will be prosecuted!
- Cleaning Reminder: Avoid using acidic or corrosive cleaning agents. Residue such as mud or cleaning solutions may damage the surface. Clean and dry promptly.

Color Options

Color Code	01 Polished Surface	02 Matte Surface
Model Number		
08001T	✓	⊙
11002T	✓	⊙
12002T	✓	⊙

Legend: ✓ Standard Product ✗ No Color Option Available ⊙ Custom Order Available



Inner and Outer Corners

Construction Scenarios



Outer Corner Assembly Diagram

Inner Corner Assembly Diagram

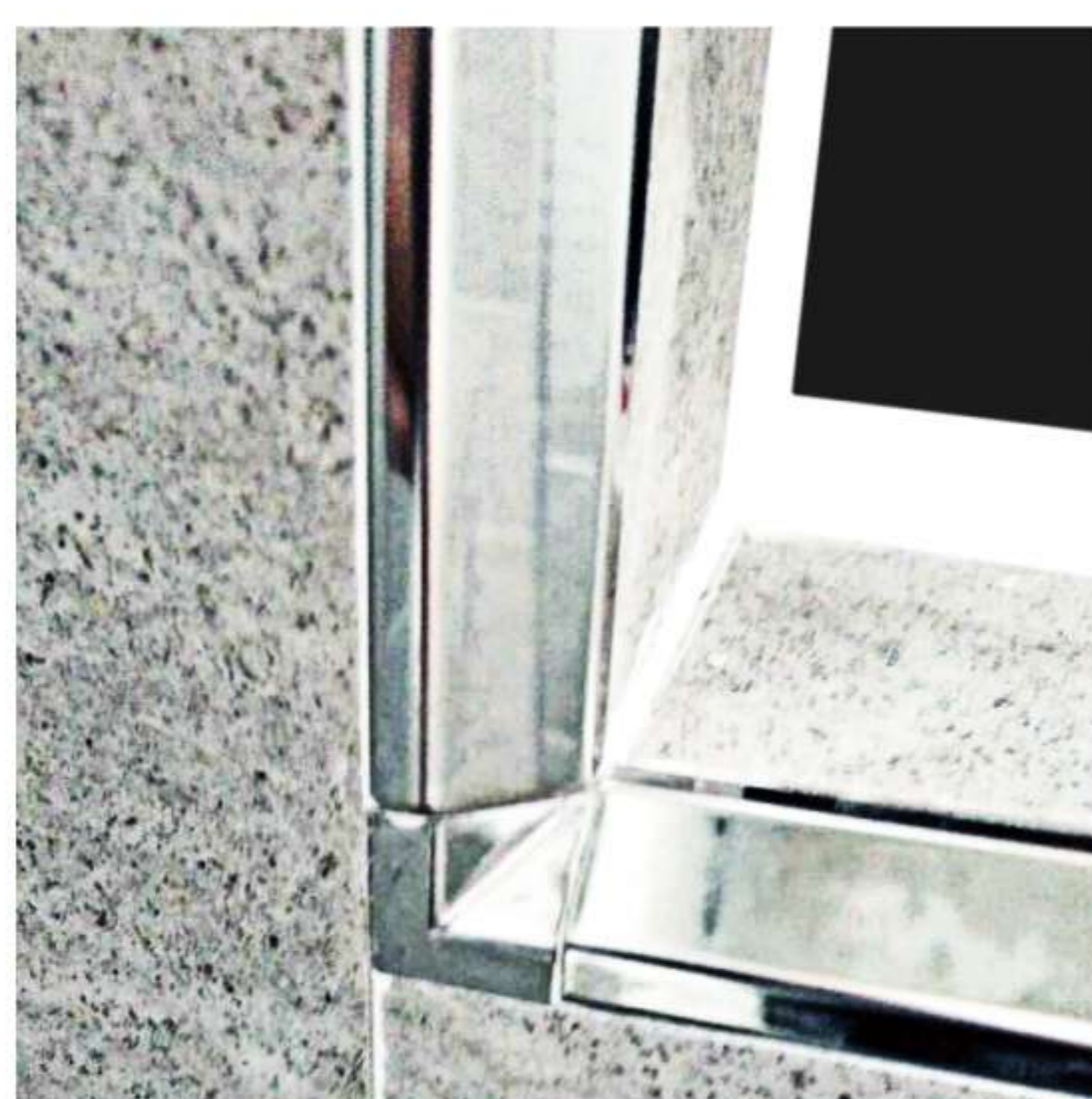



Stainless Steel Equal-Sided Square Edge Trim Series



Unit: mm

Model	Product Name	H (Height)	W (Width)	
08081L	Stainless Steel 8.3mm Equal-Sided Square Edge Trim	8.3	8.8	0.5
10101L	Stainless Steel 10.7mm Equal-Sided Square Edge Trim	10.7	11.5	0.8
12121L	Stainless Steel 12.7mm Equal-Sided Square Edge Trim	12.7	13.5	0.8

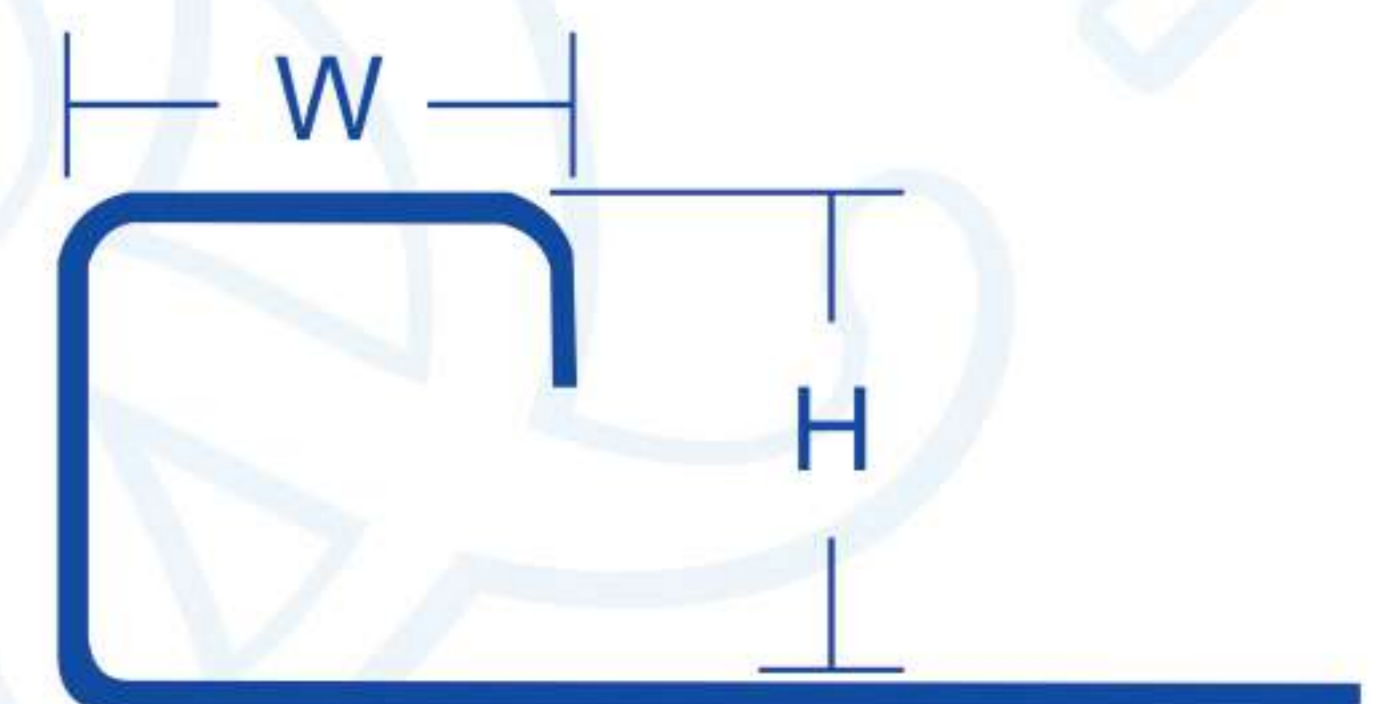

Specifications and Features

- Length: 2.5m ; made from SUS304 stainless steel with options for bright or matte finishes.
- Durability and Aesthetics: Stainless steel edge trims are sturdy, aesthetically pleasing, and offer an unmatched metallic texture.
- Applications: Suitable for door or window frames, column edges, wall waistlines, or as dividing lines for walls and floors.
- Unique Design: Features a compact and rounded corner design, combining quality with aesthetic elegance.
- Accessories: Full range of corner connectors available for seamless integration.
- Customization: Other sizes can be custom-made upon request.
- Cleaning Reminder: Avoid using acidic or corrosive cleaning agents. Residue such as mud or cleaning solutions may damage the surface. Clean and dry promptly.

Color Options

Color Code	01 Polished Surface	02 Matte Surface
Model Number		
08081L	✓	⊙
10101L	✓	✓
12121L	✓	✓

Legend: ✓ Standard Product ✗ No Color Option Available ⊙ Custom Order Available

Construction Scenarios



Inner Corner Assembly

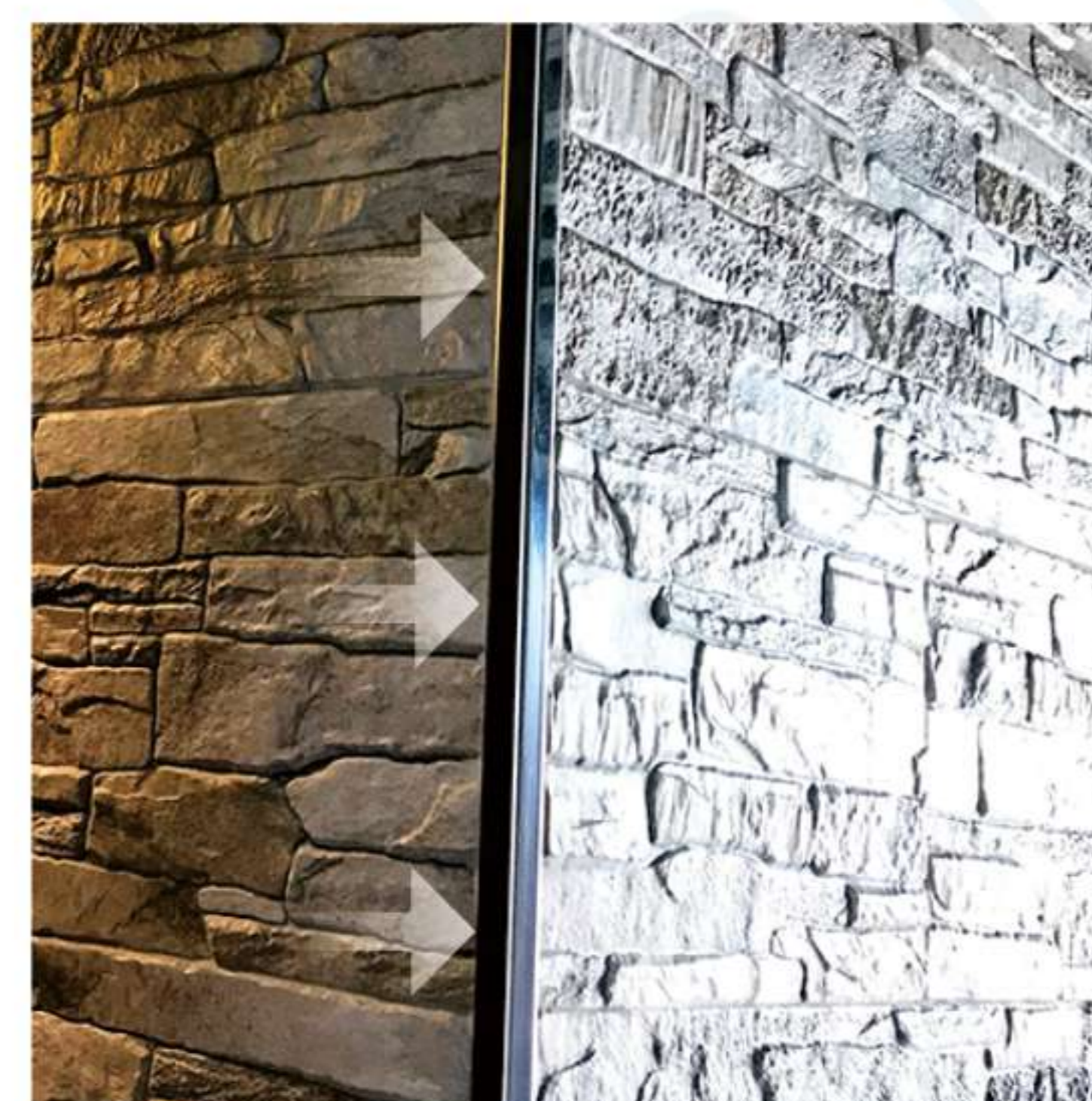



Stainless Steel Narrow Edge Square Trim Series



Corner Piece
(Universal for Inner and Outer)

Unit: mm

Model	Product Name	H (Height)	W (Width)	T (Thickness)
09061L	Stainless Steel 9.0mm Narrow Edge Square Trim	9.0	6.5	0.8
10061L	Stainless Steel 10.7mm Narrow Edge Square Trim	10.7	6.5	0.8
12061L	Stainless Steel 12.5mm Narrow Edge Square Trim	12.7	6.5	0.8

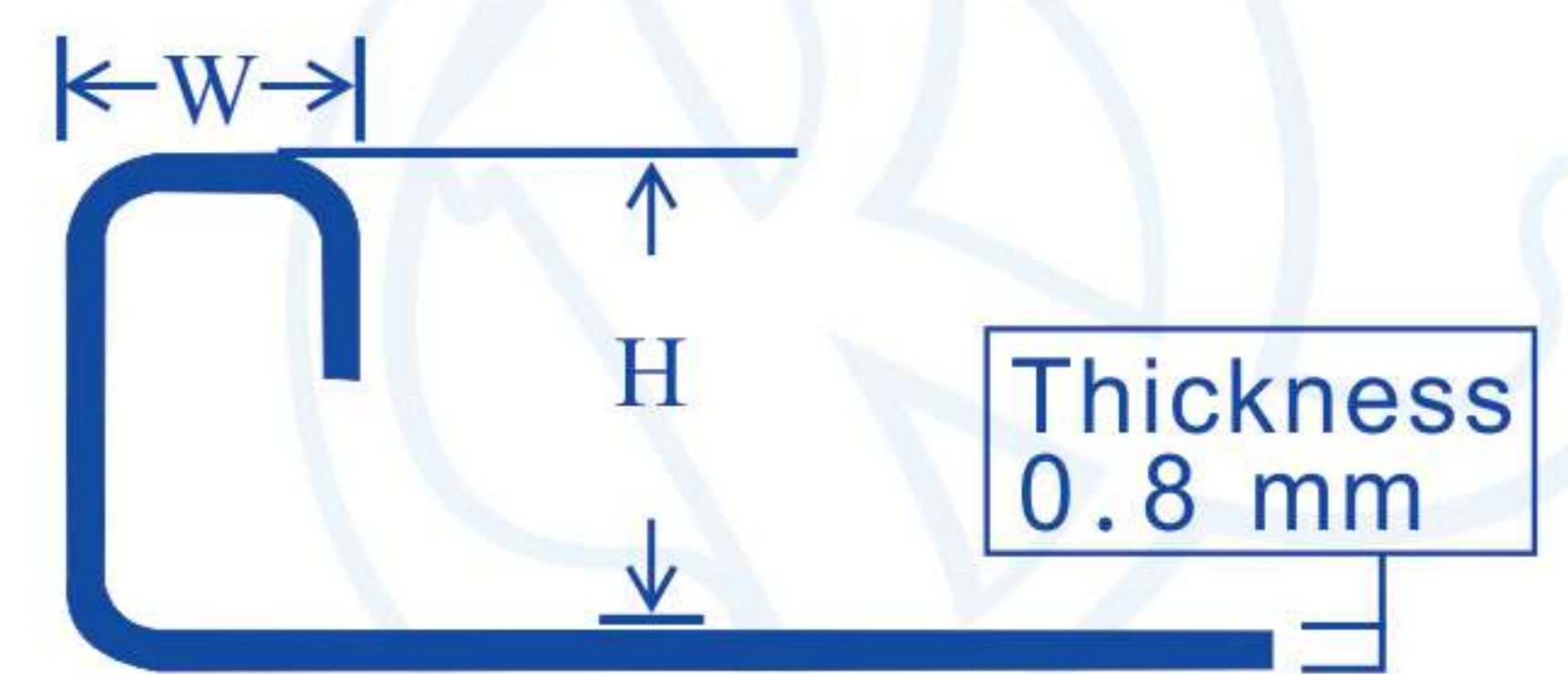

Specifications and Features

- Length: 2.5m ; made from SUS304 material with options for bright and matte finishes.
- Durability and Aesthetics: Stainless steel edge trims are sturdy, aesthetically pleasing, and offer an unmatched metallic texture.
- Applications: Suitable for dividing lines on wall waistlines or floors; Exclusive narrow surface width for delicate and refined wall trimming.
- Exclusive Rounded Corner Design: Combines quality with elegant aesthetics.
- Accessories: A full range of corner connectors is available for seamless integration.
- Custom Sizes: Other dimensions can be custom-made upon request.
- Cleaning Reminder: Avoid using cleaning agents with acidic or corrosive ingredients. Residue such as mud or cleaning solution may damage the surface. Clean and dry promptly.

Color Options

Color Code	01 Polished Surface	02 Matte Surface
Model Number		
09061L	✓	⊙
10061L	✓	⊙
12061L	✓	⊙

Legend: ✓ Standard Product ✗ No Color Option Available ⊙ Custom Order Available

Construction Scenarios



Outer Corner Assembly



Inner Corner Assembly

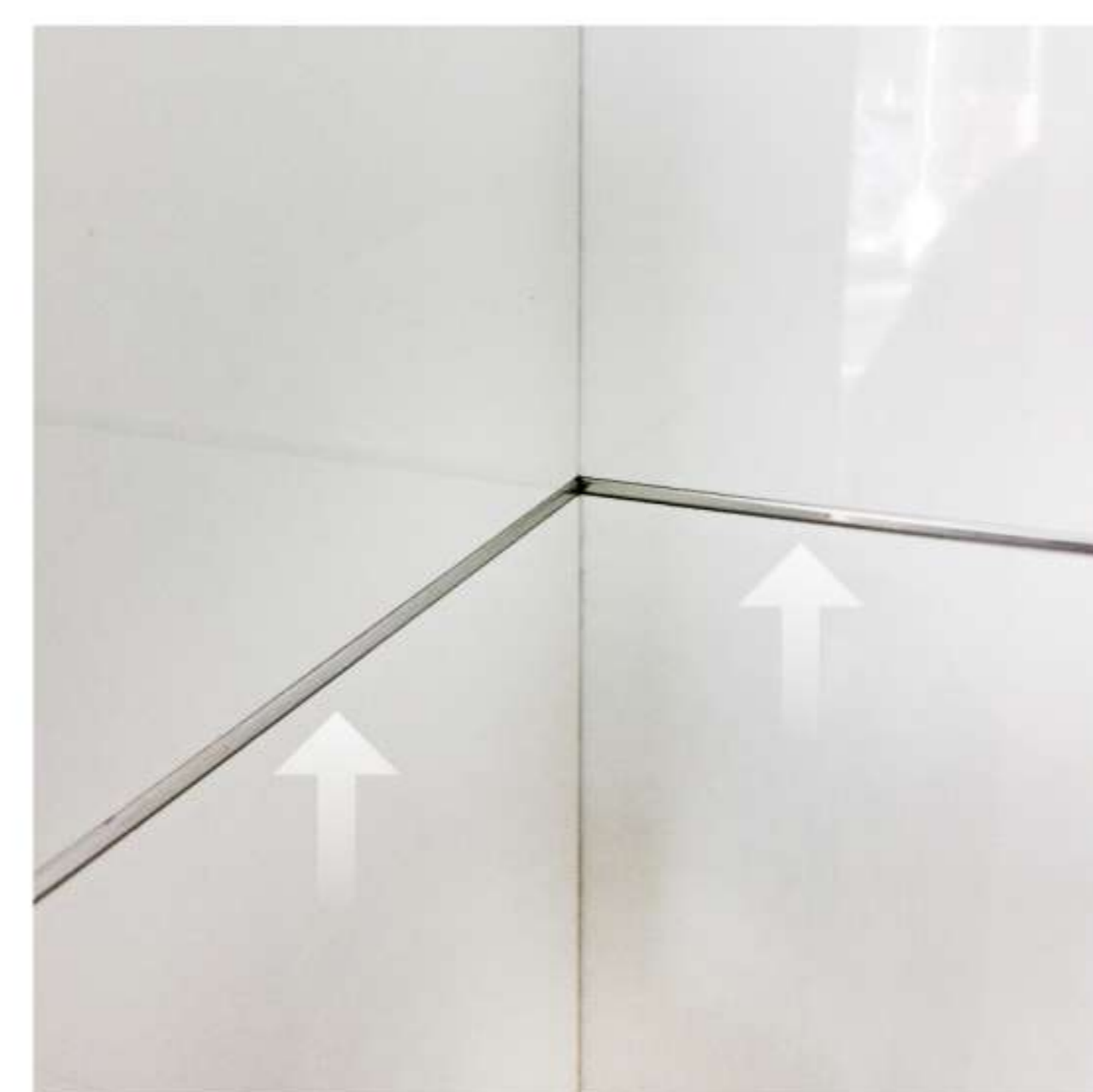



Stainless Steel Large Square Edge Trim Series



Unit: mm

Model	Product Name	H (Height)	W (Width)	T (Thickness)
11151L	Stainless Steel 11 x 15mm Large Square Trim	10.7	15	0.8
11251L	Stainless Steel 11 x 25mm Large Square Trim	10.7	25	0.8
12151L	Stainless Steel 12.5 x 15mm Large Square Trim	12.7	15	0.8
12251L	Stainless Steel 12.5 x 25mm Large Square Trim	12.7	25	0.8

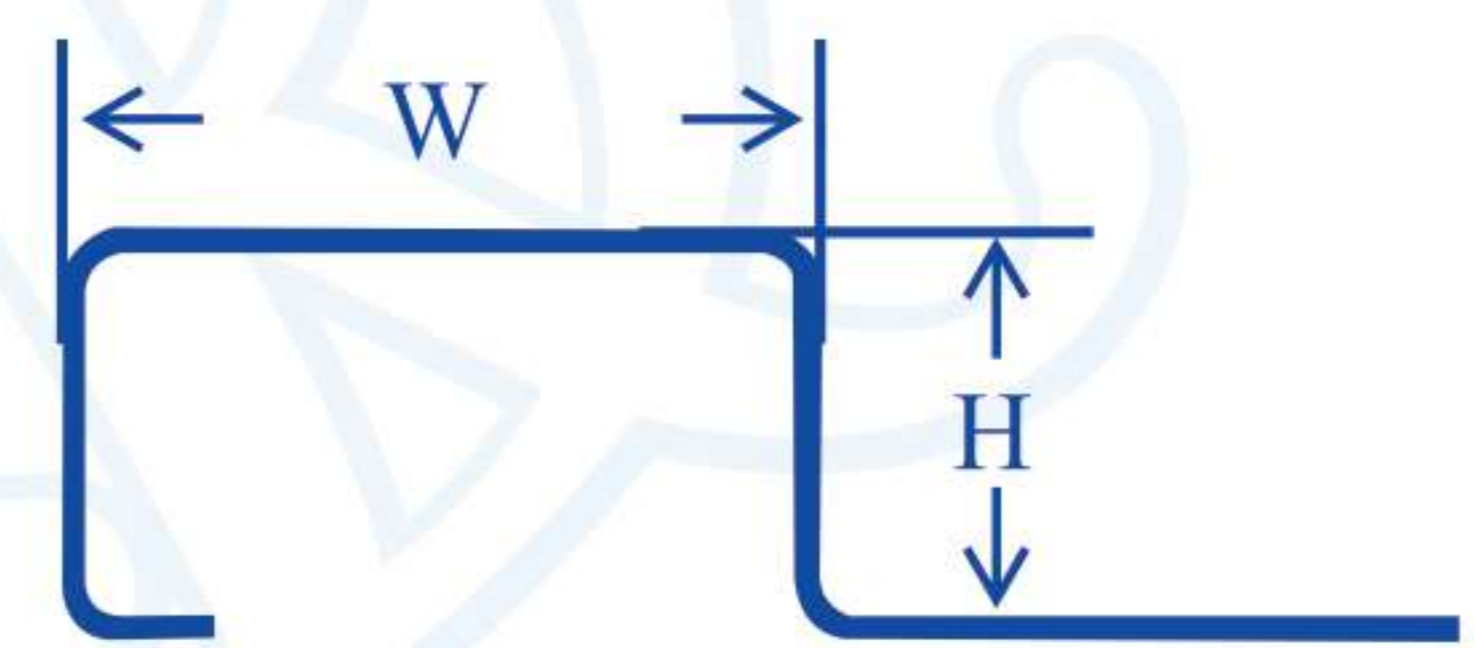



Thickness: 0.8 mm

Specifications and Features

- Length: 2.5m; material is SUS304 with options for bright or matte finishes.
- Durable and Elegant: Stainless steel edge trims are sturdy, aesthetically pleasing, Exudes an intense, rich metallic texture
- Applications: Can be used as waistline decorations on walls or as dividers on flooring.
- Exclusive Rounded Corner Design: Combines quality and aesthetic elegance.
- Full Range of Accessories: All series include corner fittings for seamless integration.
- Customization: Other sizes can be custom-made upon request.
- Cleaning Reminder: Avoid using cleaning agents containing acids or corrosive substances. Residue such as mud or cleaning solution may damage the surface; promptly clean and dry.

Color Options

Color Code	01 Polished Surface	02 Matte Surface
Model Number		
11151L	✓	⊙
11251L	✓	⊙
12151L	✓	⊙
12251L	✓	⊙

Legend: ✓ Standard Product ✗ No Color Option Available ⊙ Custom Order Available

Construction Scenarios

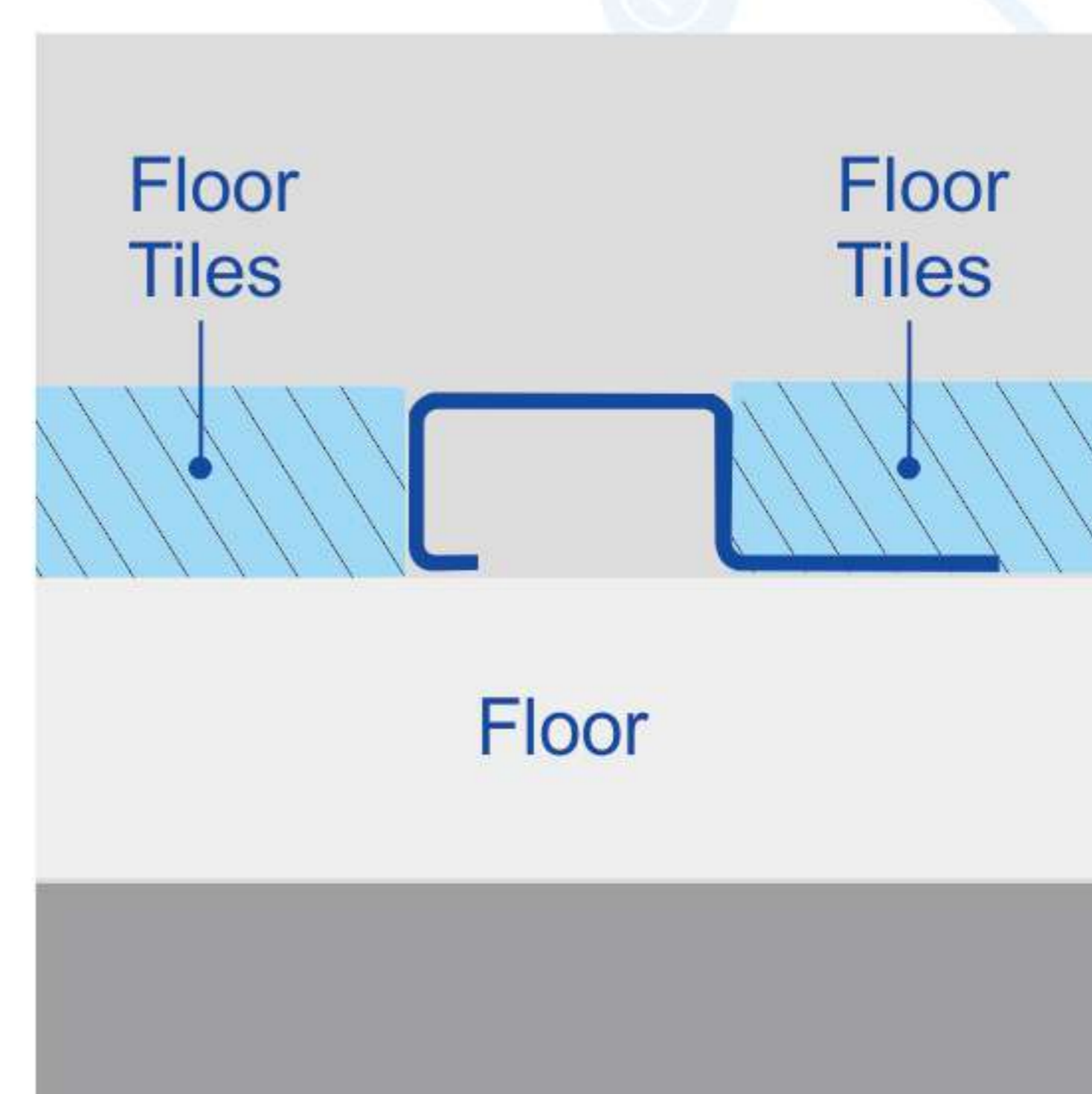
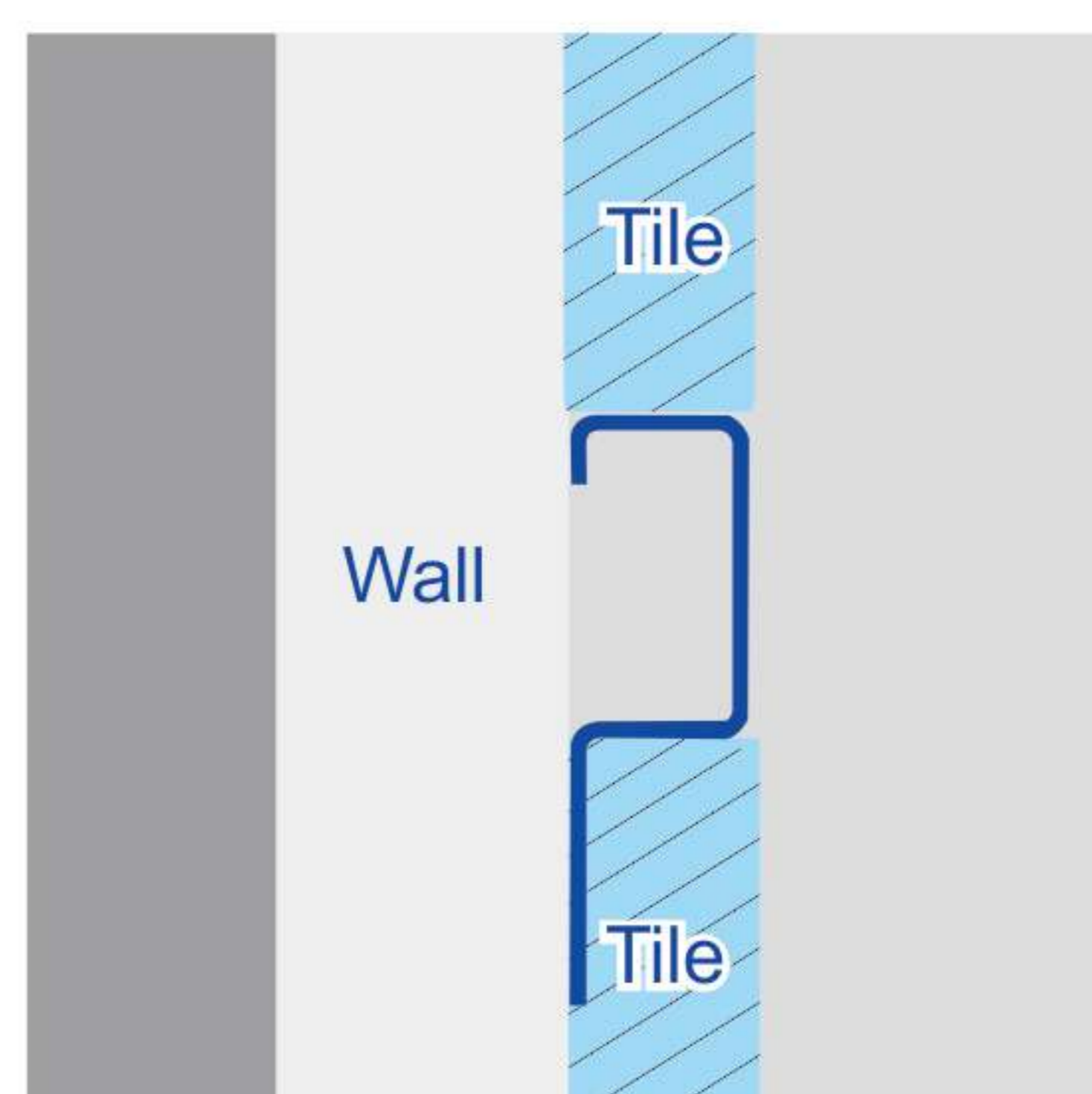



Stainless Steel Rounded Corner Trim Series



Unit: mm

Model	Product Name	H (Height)	W (Width)	
08002P	Stainless Steel 8mmThin Rounded Corner Trim	8.5	8.6	0.5
10002P	Stainless Steel 10mmThin Rounded Corner Trim	10.2	10.2	0.5
12002P	Stainless Steel 12mmThin Rounded Corner Trim	12.2	12.2	0.5
10003P	Stainless Steel 10mm Impact-Resistant Rounded Corner Trim	10.2	10.2	0.8
12003P	Stainless Steel 12mm Impact-Resistant Rounded Corner Trim	12.2	12.2	0.8

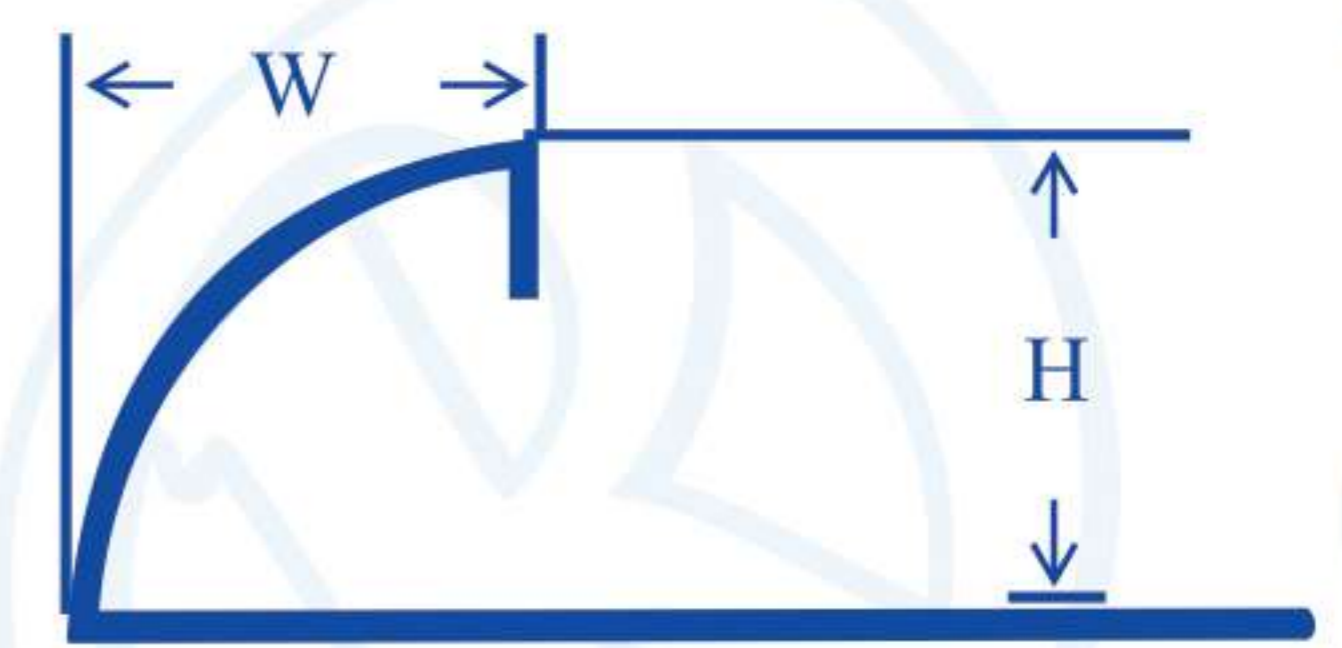

Specifications and Features

- Length: 2.5m ; Material: SUS304 stainless steel, available in polished and matte finishes.
- Stainless steel trim is robust and durable, offering a modern aesthetic. The cold metallic texture is irreplaceable.
- Thin rounded corner trim can be applied to: columns, stair edges, window frames, and door frames, featuring an integrated rounded corner finish with superior texture.
- Impact-resistant rounded corner trim is suitable for: floors, window frames, door frames, and edge protection. Increased thickness enhances impact resistance while maintaining external perfection.
- Exclusive small rounded corner design, combining functionality and aesthetics.
- All series can be matched with corner components.
- Caution: Avoid using cleaning agents containing strong acids or alkalis, as they may corrode the surface. Residual cement or cleaning agents should be promptly rinsed off.

Color Options

Color Code	01 Polished Surface	02 Matte Surface
Model Number		
08002P	✓	⊙
10002P	✓	✓
12002P	✓	✓
10003P	✓	⊙
12003P	✓	⊙



Construction Scenarios



Outer Corner Assembly



SGS Inspection Report



材料暨工程實驗室-高雄

試驗報告



報告編號: KK-22-08385
頁數: 1 OF 2
報告日期: 111年09月08日

瑞克大衛國際有限公司

產品名稱: 鋁合金修邊條
產品顏色: 陽極處理
製造廠商: 瑞克大衛國際有限公司
供應廠商: 瑞克大衛國際有限公司
送驗廠商: 瑞克大衛國際有限公司
收件日期: 111年08月15日
試驗日期: 111年08月15日~111年08月26日
試驗方法: ASTM B117-19

備註: 1. 以上資料(產品名稱、送驗廠商、收件日期及試驗日期除外)及下述報告內容標示#處係由顧客提供
2. 除非另有說明, 此報告結果僅對測試之樣品負責
未經本公司事先書面同意, 此報告不可部分複製

試驗結果:

#試件名稱	鹽霧試驗
鋁合金修邊條	試驗 100 小時後, 測試面無任何可見的變化。

註: 本試驗報告之試驗地點同實驗室地址。

測試條件:

1. 鹽液濃度	: 5 %	6. 測試時間	: 100 Hours
2. 收集鹽霧酸鹼值	: 7.0	7. 噴霧量	: 1.3 ml/hr
3. 供給空氣壓力	: 1.0 kg/cm ²	8. 收集鹽霧比重	: 1.032
4. 鹽霧室之溫度	: 35.0°C	9. 試件與垂直線角度	: 20°
5. 飽和空氣溫度	: 47.0°C		

----- 1 -----

報告簽署人

本報告若有提供規範值, 該規範值僅供參考, 合格之判定以委託單位實際要求為準

This document is issued by the Company subject to its General Conditions of Service printed overleaf, available on request or accessible at <http://www.sgs.com.tw/Terms-and-Conditions> and, for electronic format documents, subject to Terms and Conditions for Electronic Documents at <http://www.sgs.com.tw/Terms-and-Conditions>. Attention is drawn to the limitation of liability, indemnification and jurisdiction issues defined therein. Any holder of this document is advised that information contained hereon reflects the Company's findings at the time of its intervention only and within the limits of Client's instructions, if any. The Company's sole responsibility is to its Client and this document does not exonerate parties to a transaction from exercising all their rights and obligations under the transaction documents. This document cannot be reproduced except in full, without prior written approval of the Company. Any unauthorized alteration, forgery or falsification of the content or appearance of this document is unlawful and offenders may be prosecuted to the fullest extent of the law. Unless otherwise stated the results shown in this test report refer only to the sample(s) tested.

SGS Taiwan Ltd. No.61, Kai Fa Rd., Nanzih District, Kaohsiung City 811637, Taiwan / 811637 高雄市楠梓區開發路61號
台灣檢驗科技股份有限公司 (886-7) 301-2121 (886-7) 301-1165 www.sgs.com.tw

Member of SGS Group

circe_kung



材料暨工程實驗室-高雄

試驗報告



報告編號: KK-22-06991
頁數: 1 OF 2
報告日期: 111年08月01日

瑞克大衛國際有限公司

產品名稱: 鋁合金導水板
產品顏色: 烤漆鐵灰色
製造廠商: 瑞克大衛國際有限公司
供應廠商: 瑞克大衛國際有限公司
送驗廠商: 瑞克大衛國際有限公司
收件日期: 111年07月07日
試驗日期: 111年07月07日~111年07月19日
試驗方法: ASTM B117-19

備註: 1. 以上資料(樣品名稱、送驗人員、會驗人員、試驗方法、試驗數量、收件日期及試驗日期除外)及下述報告內容標示#處係由顧客提供
2. 除非另有說明, 此報告結果僅對測試之樣品負責
未經本公司事先書面同意, 此報告不可部分複製

試驗結果:

#試件名稱	鹽霧試驗
鋁合金導水板	試驗 100 小時後, 測試面無任何可見的變化。

註: 本試驗報告之試驗地點同實驗室地址。

測試條件:

1. 鹽液濃度	: 5 %	6. 測試時間	: 100 Hours
2. 收集鹽霧酸鹼值	: 7.0	7. 噴霧量	: 1.3 ml/hr
3. 供給空氣壓力	: 1.0 kg/cm ²	8. 收集鹽霧比重	: 1.034
4. 鹽霧室之溫度	: 35.0°C	9. 試件與垂直線角度	: 22°
5. 飽和空氣溫度	: 47.0°C		

----- 1 -----

報告簽署人

本報告若有提供規範值, 該規範值僅供參考, 合格之判定以委託單位實際要求為準

This document is issued by the Company subject to its General Conditions of Service printed overleaf, available on request or accessible at <http://www.sgs.com.tw/Terms-and-Conditions> and, for electronic format documents, subject to Terms and Conditions for Electronic Documents at <http://www.sgs.com.tw/Terms-and-Conditions>. Attention is drawn to the limitation of liability, indemnification and jurisdiction issues defined therein. Any holder of this document is advised that information contained hereon reflects the Company's findings at the time of its intervention only and within the limits of Client's instructions, if any. The Company's sole responsibility is to its Client and this document does not exonerate parties to a transaction from exercising all their rights and obligations under the transaction documents. This document cannot be reproduced except in full, without prior written approval of the Company. Any unauthorized alteration, forgery or falsification of the content or appearance of this document is unlawful and offenders may be prosecuted to the fullest extent of the law. Unless otherwise stated the results shown in this test report refer only to the sample(s) tested.

SGS Taiwan Ltd. No.61, Kai Fa Rd., Nanzih District, Kaohsiung City 811637, Taiwan / 811637 高雄市楠梓區開發路61號
台灣檢驗科技股份有限公司 (886-7) 301-2121 (886-7) 301-1165 www.sgs.com.tw

Member of SGS Group

circe_kung



DESIGN IN TAIWAN
MADE IN TAIWAN

Applications in various spaces
style comes from the details.



Aluminum P15
Skirting Board Series

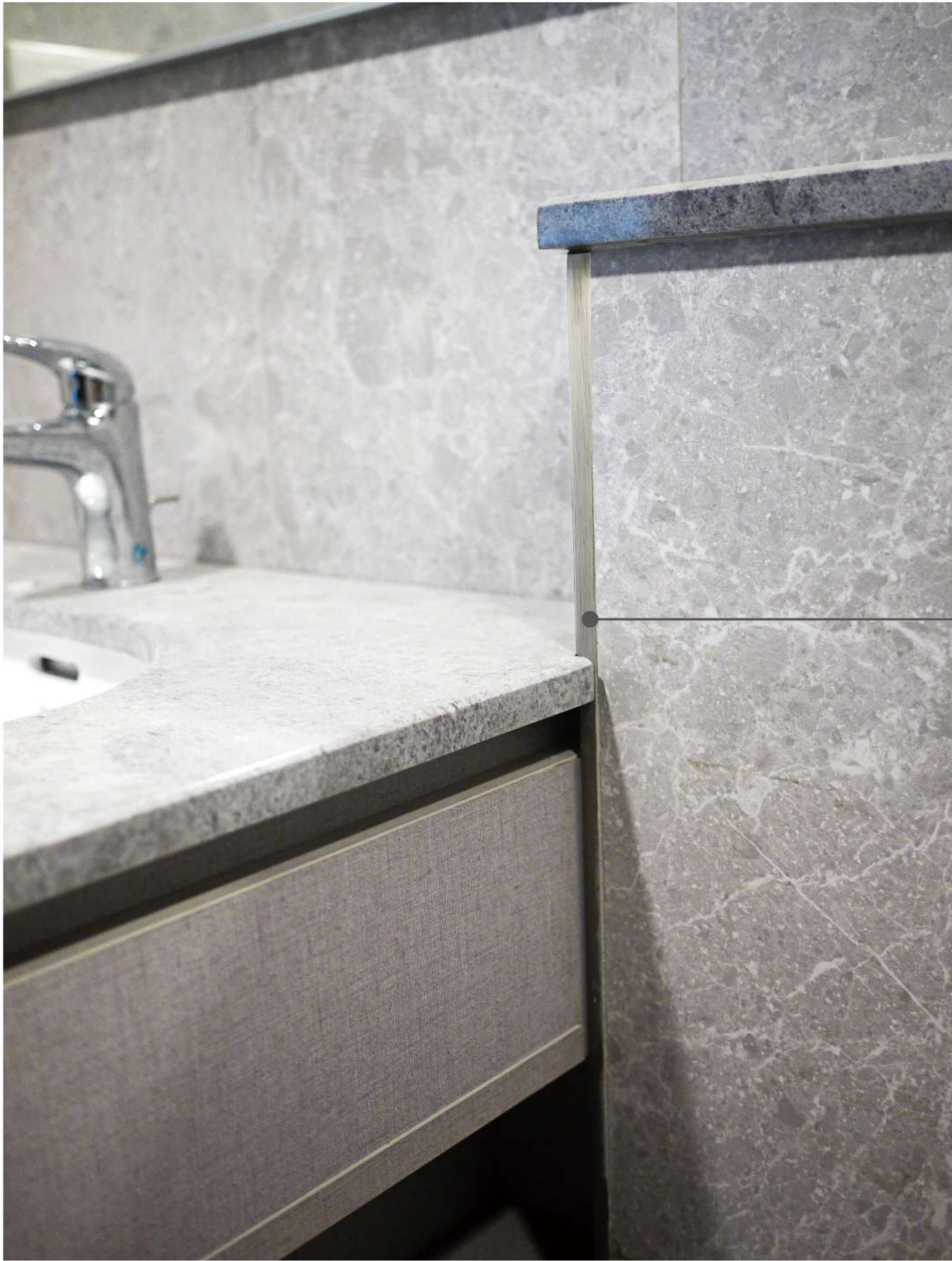

Aluminum P03
Alloy Square Edge Trim Series
Color Code : Silk Pattern Champagne

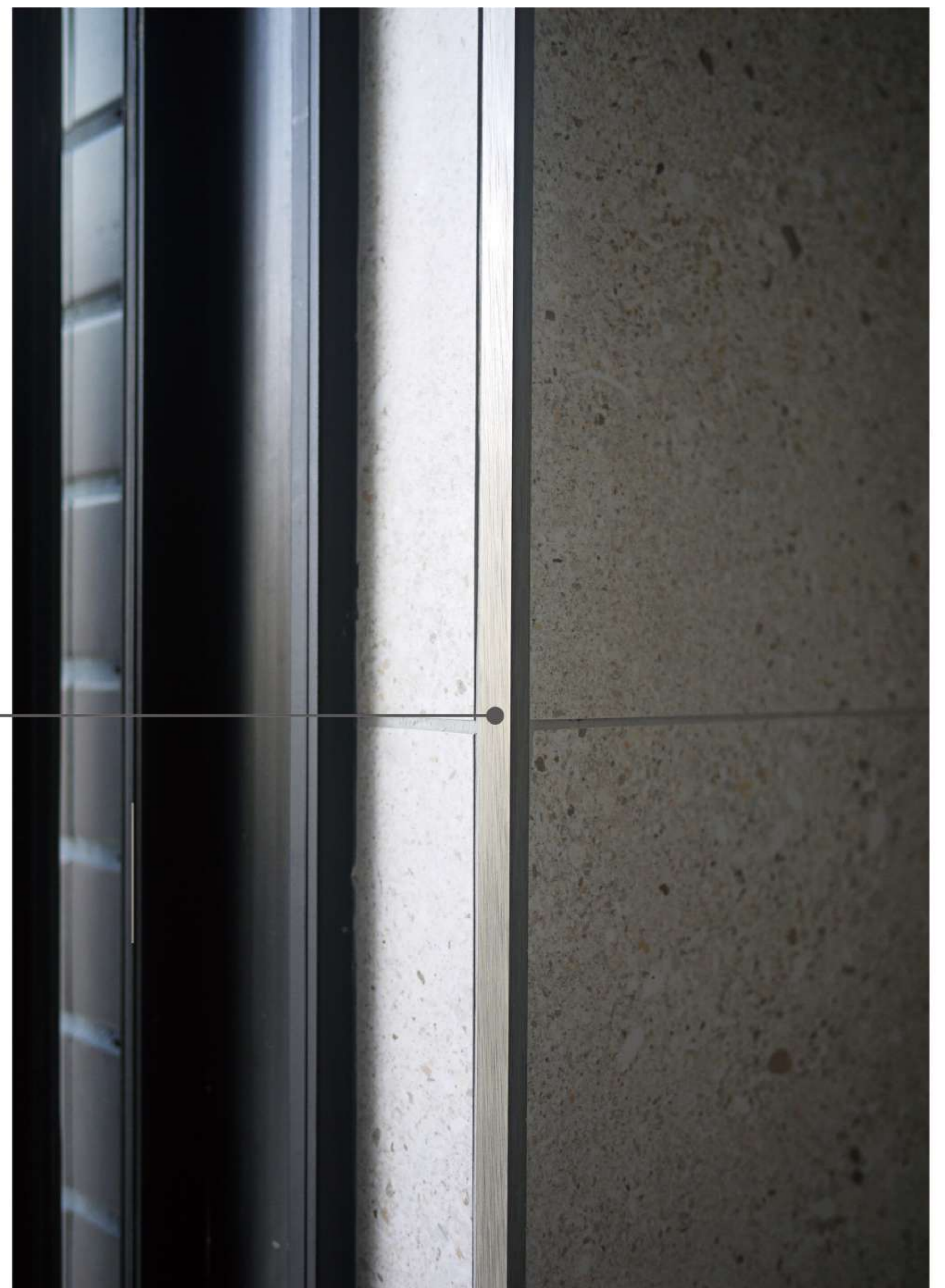

Aluminum P03
Alloy Square Edge Trim Series
Color Code : Silk Pattern Champagne



**Pre-Installation P16
Recessed Skirting
Board Series**

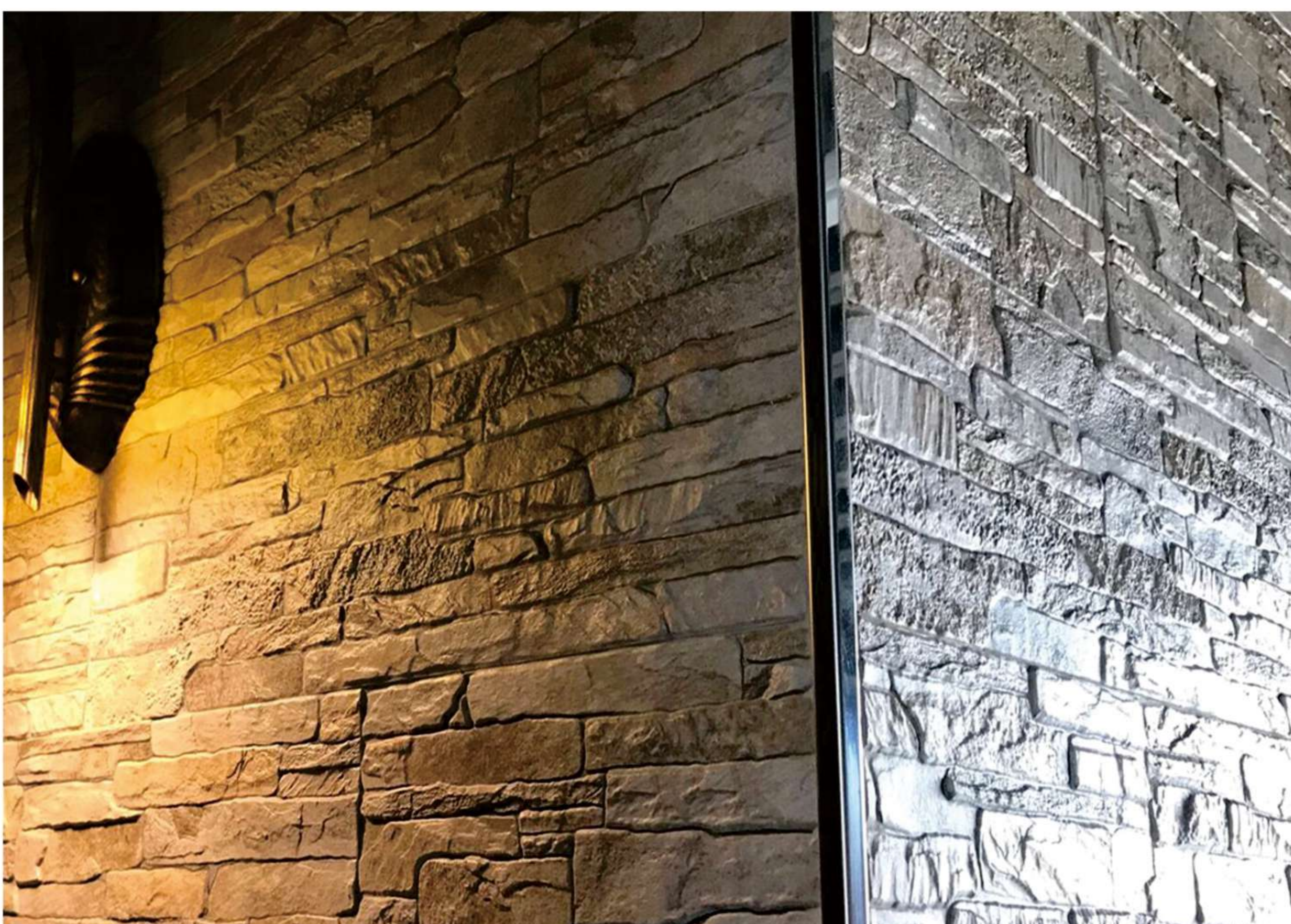
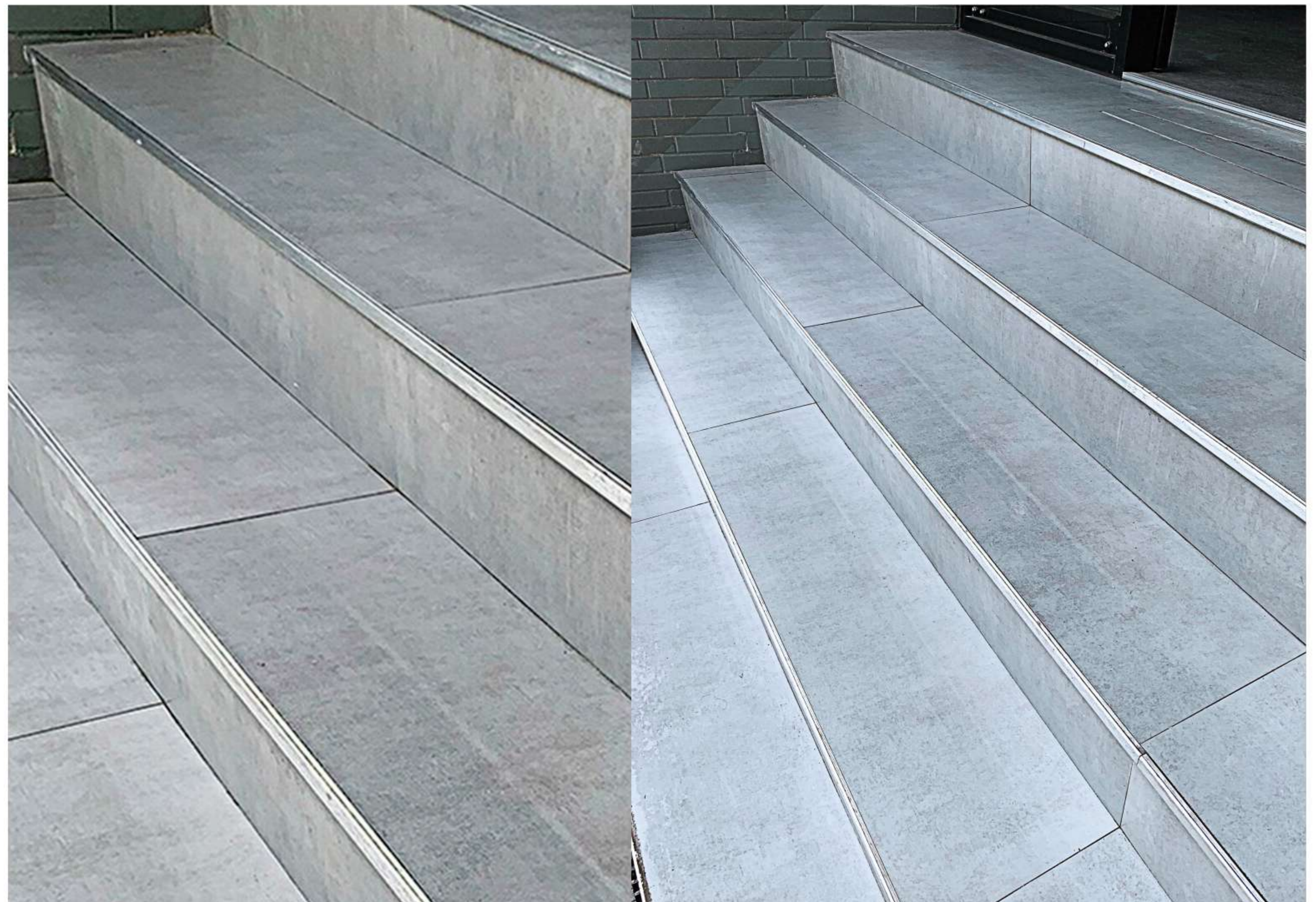

**Stainless P28
Steel Equal-Sided
Square Edge Trim Series**





R&D Quality Building Materials
R&D International Ltd.

